



Home Vegetable Gardening in Kentucky





Front cover: Chinese cabbage 'Pak Choi Asian Delight' is a 2018 Vegetable Award Winner from All-America Selections. Chinese cabbage is a leafy vegetable that can be added to salads when picked young or added to stir fry or steamed when mature. 'Pak Choi Asian Delight' matures quickly in the garden but is slower to bolt than other cultivars of Chinese cabbage so extended harvest can be realized. In Kentucky, Chinese cabbage can be planted in either spring or fall but does best as a fall vegetable when planted in late summer. The flavor is more intense when harvested after a light frost.

For more information about this and other AAS Vegetable Winners visit the AAS web site at: www.all-americaelections.org.

Contents

| | |
|---|----|
| Plans and Preparations | |
| Before You Begin | 3 |
| Planning Your Garden | 3 |
| Choosing a Site | 3 |
| Organic Gardening | 3 |
| Preparing the Soil | 4 |
| Preparing a New Garden Site | 6 |
| Crop Rotation | 7 |
| Pest Control | 7 |
| Planting | |
| General Considerations | 8 |
| Transplants | 8 |
| Growing More with Less Space | |
| Intensive Gardening | 11 |
| Container Gardening | 12 |
| Mini-Gardens | 12 |
| One Garden Plot: Three Garden Seasons | |
| The Spring Garden | 14 |
| The Summer Garden | 14 |
| The Fall Garden | 15 |
| Extending the Growing Season | 15 |
| Caring for Your Vegetables | |
| During the Growing Season | |
| Irrigating | 17 |
| Mulching | 19 |
| Fertilizing | 20 |
| Compost | 20 |
| Cover Crops Protect Garden Plots | 21 |
| Diseases, Insects and Weeds | |
| Disease Control | 22 |
| Insect Control | 24 |
| Weed Control | 28 |
| Storing Vegetables | 29 |
| What You Should Know about | |
| Asparagus through Watermelons | |
| Asparagus | 30 |
| Beans..... | 31 |
| Beets, Broccoli, Brussels Sprouts | 32 |
| Cabbage, Carrots, Cauliflower | 33 |
| Chinese Cabbage, Collards, Cucumber..... | 34 |
| Eggplant, Garlic, Kale, Leeks | 35 |
| Lettuce, Muskmelons, Mustard Greens | 36 |
| Okra, Onions, Parsnips | 37 |
| Peas, Peppers, Potatoes | 38 |
| Pumpkins..... | 39 |
| Radishes, Rhubarb, Southern Peas, Spinach | 40 |
| Squash, Sweet Corn..... | 41 |
| Sweet Potatoes, Swiss Chard, Tomatoes..... | 42 |
| Turnips, Watermelons..... | 44 |

Acknowledgments

Contributors to this publication:

Richard Durham
Department of Horticulture, Editor

John Strang

Mark Williams

Shawn Wright

Department of Horticulture

Ric Bessin

Department of Entomology

Brad Lee

Department of Plant and Soil Sciences

Emily Pfeufer

Department of Plant Pathology

For further information on home vegetable gardening, contact
Richard Durham, Department of Horticulture, University of Kentucky.

Mention or display of a trademark, proprietary product or firm in text or figures does not constitute an endorsement and does not imply approval to the exclusion of other suitable products or firms.

Plans and Preparations

Before You Begin

Every aspiring gardener should follow seven steps to have a successful gardening season:

1. Plan your garden on paper before you begin.
2. Select a good gardening site that is:
 - a. in full sun for at least eight hours each day,
 - b. relatively level,
 - c. well-drained,
 - d. close to a water source,
 - e. dries quickly from morning dew.
3. Prepare the soil properly, conduct a soil test, and add fertilizer and lime according to U.K. test result recommendations.
4. Plan only as large a garden as you can easily maintain. Beginning gardeners often overplant, and then they fail because they cannot keep up with the tasks required. Weeds and pests must be managed, water applied when needed and harvesting done on time.
5. Grow vegetables that will produce the maximum amount of food in the space available.
6. Plant during the correct season for the crop.
7. Choose varieties recommended for Kentucky.
8. Harvest vegetables at their proper stage of maturity. Store them promptly and properly if you do not use them immediately.

Planning Your Garden

A garden plan helps you grow the greatest amount of produce with the least amount of effort. To use your plan you must expect to harvest each crop as soon as it matures. Then put old plants in the compost pile and plant a new crop. This approach is called succession planting.

Grow only those vegetables that your family will eat. A well-planned and properly kept garden should produce 600 to 700 pounds of produce per 1000 square feet and may include many different crops. Consult *Vegetable Cultivars for Kentucky Gardens* (ID-133) for the latest recommendations on home vegetable varieties.

Draw a scale model of your garden space when planning where to plant. There are also a number of computer programs that can be used to plan your garden. Plant perennials like asparagus, rhubarb, chives and horseradish along one side of the garden since they may produce for six to 12 years. Tall plants such as sweet corn, tomatoes and pole beans should be planted on the north or west side of the garden where they will not shade smaller vegetable crops. However, summer lettuce should be grown in a partially shaded area if possible.

Choosing a Site

Your garden site should provide a sunny exposure, adequate moisture and fertile soil. Because of your property's limitations, however, you may be forced to select a less than ideal location. As much as possible, let the following suggestions guide you in choosing your garden site:

Avoid putting the garden in a low spot, at the bottom of a hill or at the foot of a slope bordered by a solid fence. Such areas, where frost set-

gles because of lack of air drainage, are slow to warm up in the spring. High ground will enable the vegetables to escape "borderline" freezes for an earlier start in the spring and longer harvest in the fall.

If possible, choose an area with a southern or southeastern exposure which warms up faster in the spring and receives the maximum amount of sunlight throughout the growing season. Midsummer vegetables, other than lettuce, should not be located on the north side of a building or on a northern slope of a hillside.

Plant your vegetables away from buildings, trees and other objects which would shade them. Your plants need at least eight hours of direct sunlight each day. You can grow lettuce in the shade if you must locate part of your garden in a partially shaded area.

Your garden needs water from rainfall or other sources. However, too much water can be just as damaging as too little.

- Examine your garden site to see how it drains and avoid areas that stay soggy after a rain. To evaluate how your site drains, dig a small diameter hole to a depth of two feet and look for grey colors in the soil. These grey colors indicate that the soil is poorly drained. Consider moving the garden to a different area or installing raised beds.
- Avoid heavy clay soils in favor of loamy soil.
- Improve sandy soils by adding large amounts of organic matter. Adding organic matter can often solve minor drainage problems; however, if the poor drainage is caused by underlying layers of rock or hard clay (hardpan), correcting the drainage could involve the labor and expense of subsoiling with an excavator, laying tile or of building raised beds.
- Locate your garden away from trees as much as possible. Tree roots can compete with your vegetables for water and nutrients.
- Look for a site which supports lush vegetative growth, even if it is dark green, sturdy weeds. Although you can improve poor soil over a period of years, you can save much time and work if you begin with naturally rich soil.
- Make sure to use contour rows or terraces for hillside gardens.
- Avoid windy locations.

Finally, the closer the vegetable garden is to your back door, the more you will use it. You can see when your crops are at their peaks and can take maximum advantage of their freshness. Also, keeping up with planting, weeding, watering and pest control will be easier.

Organic Gardening

In 1990 Congress passed the Organic Foods Production Act, which mandated the creation of the National Organic Program (NOP) and the passage of uniform organic standards. This action was followed by over a decade of public input and discussion, which resulted in a National Organic Program final rule implemented in October 2002. These national standards set out the methods, practices and substances used in producing and handling all certified organic crops and livestock. The standards include a national list of approved non-synthetic and prohibited synthetic substances for organic production.

Organic production is based on a system of farming that maintains and replenishes soil fertility without the use of toxic and persistent pesticides and fertilizers. Organically produced foods also must be produced without the use of antibiotics, synthetic hormones, genetic engineering and other excluded practices, sewage sludge, or irradiation. National organic standards require that organic growers and handlers be certified by third-party state or private agencies or other organizations that are accredited by USDA.

Home gardeners will have no need to concern themselves with the many rules and requirements that go along with organic certification. However gardening organically in your home garden in Kentucky is just as easy as gardening using “conventional” techniques and inputs once you master some simple management practices like scouting your garden often to watch for pest or disease problems, choosing plant varieties that will thrive under organic management, and paying close attention to soil management by adding organic matter to your garden, using compost, practicing crop rotation, and utilizing cover crops. Throughout this guide, organic alternatives to certain conventional practices or inputs are included to give gardeners a choice in how they raise vegetables.

Preparing the Soil

An ideal garden soil has a 10- to 12-inch loamy surface layer overlying a well-drained subsoil. This type of soil can retain large amounts of water but still drains well after a rain. After spring preparation, it stays crumbly and workable without becoming hard and crusted. It should have enough minerals for optimum growth, and the pH should be between 6.2 and 6.8.

Few sites available for the home vegetable garden will match the ideal in all respects. However, most soils can be modified to provide more favorable growing conditions. Soil improvement is really a long-term process, often taking several years. The poorer the soil, the longer it will take to get optimum production from it. However, vegetable crops will tolerate variable soil conditions and still produce fairly well.

After a fertile garden is established, continue amending the soil so that it will stay fertile and workable. Since most gardens must be in the same location year after year, building up a rich soil is essential.

The Soil Test

After deciding on your garden site, take a soil sample and have it tested, preferably in October or November. Use the soil test as a guide as you try to establish a satisfactory fertility level. The standard test measures soil acidity (pH), available phosphorus, potassium and, if requested, calcium, magnesium and zinc. The test results help determine fertilizer and lime requirements.

To take a soil sample, push a spade 7 inches into the soil and throw the soil aside. Take another 1-inch slice of soil from the back of the hole the full depth of the hole. Remove all the soil but the center 1- to 2-inch-wide core. Place this core of soil in a clean bucket (Figure 2).

Figure 1. Garden plan for a family of four—layout and planting dates (ensure 2.5 feet between rows if using a rototiller for cultivation).

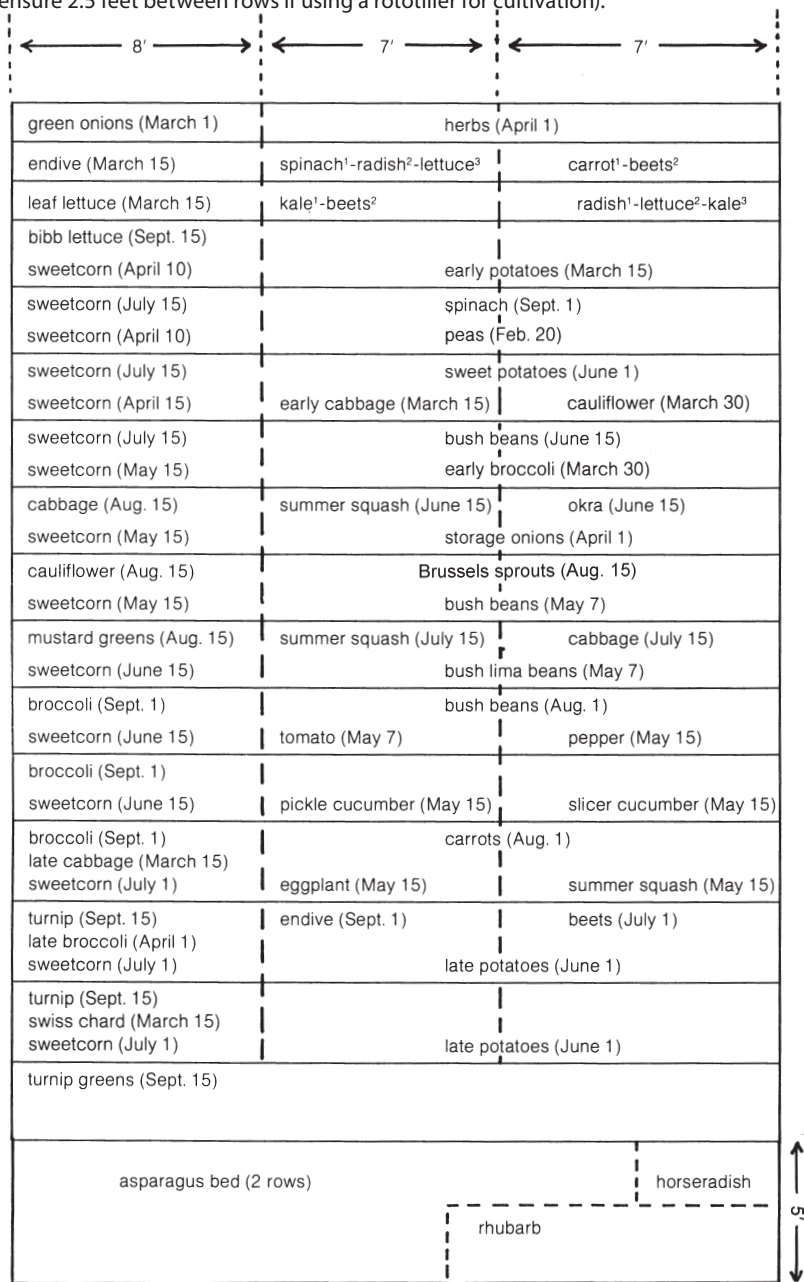

Code: 1 = First planting (March 15); 2 = Second planting (June 15); 3 = Third planting (Aug. 15)

Repeat the procedure in different spots to get a representative sample of the whole garden and to get about 1 pint of soil. Mix the composite sample well and put it on some paper to dry for about two days at room temperature. Then take it to your county Extension office to submit for analysis. The cost of the soil test, which varies with the number of elements tested, will be returned to you many times over in savings of fertilizer and in the production of high yields and quality produce.

Soil pH—Why Is It Important?

The term pH stands for the relationship of hydrogen ions (H+) to hydroxyl ions (OH-). A soil pH reading indicates on a logarithmic scale the concentration of ions held to soil particles and organic matter. A pH scale ranges from 0 to 14, with pH 7.0 being neutral. Readings below 7.0 indicate a soil is “acid,” and read-

ings above 7.0 indicate “alkaline” soil conditions. Most of the plants we grow in our home gardens require a soil which is slightly acid.

The soil’s pH is very important because it directly affects soil nutrient availability (Figure 3). Plant roots can only absorb nutrients after they have been broken down into certain ion forms. Only at certain pH ranges can sufficient amounts of these nutrients be broken into these ion forms. When the soil’s pH is out of this range, the nutrients are “tied up in the soil.” By adjusting the pH, we make sure that the plants we grow can use the fertilizers and available nutrients in the soil to their fullest potential. Most vegetables in a garden prefer growing in soil with a pH between 6.2 and 6.8.

Autumn is an excellent time to have your soil tested. You can then make any adjustments of pH needed with limestone or sulfur applications. Also, getting test results in the fall helps you plan your fertilizing needs for the coming year’s garden. Contact your Cooperative Extension office about soil testing.

Adjusting pH

If soil test results indicate that your soil’s pH falls out of the ideal range of 6.2 to 6.8, you may need to add lime or sulfur, depending on your soil’s pH value. If the pH is too low, then your soil is too acid and you should either add calcitic or dolomitic limestone (Table 1). If the pH value is too high, your soil is too alkaline and you need to add sulfur (Table 2). Applying lime or sulfur in the fall before planting is best because you have a longer soil reaction time. Lime rates shown in Table 1 are in terms of agricultural limestone. By regulation in Kentucky, aglime must have a purity equivalent to 80% or higher pure calcium carbonate. It must be ground finely enough so that 90% will pass through a 10-mesh screen and 35% will pass through a screen size of 50-mesh. The purity (% calcium carbonate equivalent) is an index of the amount of active ingredient per unit weight, while particle size of the liming material is an index of how rapidly the material will dissolve when mixed with soil. The more finely ground the liming material, the faster it dissolves.

Use of Wood Ashes

Wood ashes have some use as a liming material, although they are relatively scarce. Their rather low neutralizing value ranges from 30% to 70%, expressed as calcium carbonate. The ash of

hardwoods, such as maple, elm, oak and beech, contains about one-third more calcium mainly as the oxide, but, on exposure to moisture, they are largely in the carbonate form by the time they are applied to soil.

Figure 2. Taking a soil sample.

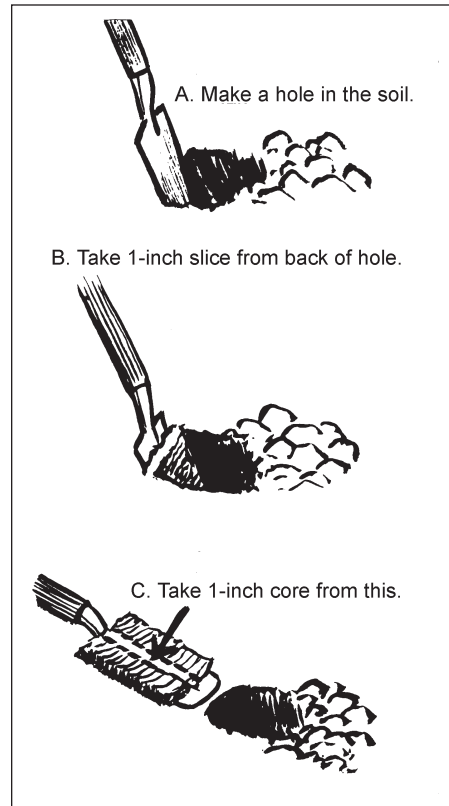

Figure 3. Effect of change in pH on the availability of plant nutrients.

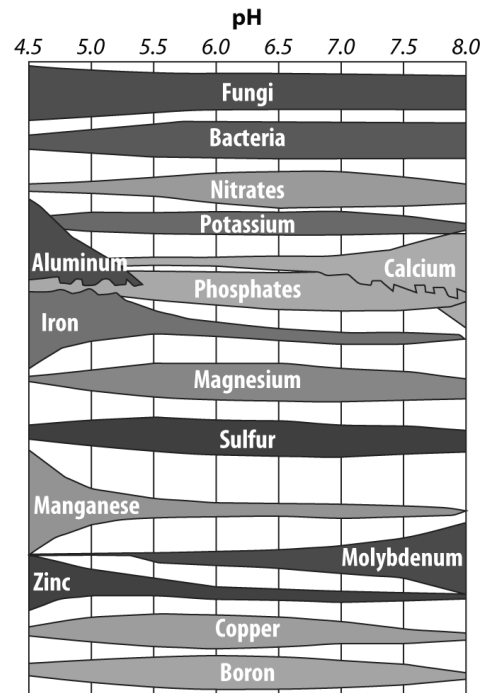

Table 1. Rate (lb/1000 sq ft)¹ of Agricultural Limestone Needed to Raise Soil pH to 6.4.

| Water pH of Sample | Buffer pH of Sample | | | | | | | | If Buffer pH is Unknown |
|--------------------|---------------------|-----|-----|-----|-----|-----|-----|-----|-------------------------|
| | 5.5 | 5.7 | 5.9 | 6.1 | 6.3 | 6.5 | 6.7 | 6.9 | |
| 4.5 | 320 | 300 | 280 | 250 | 220 | 180 | 150 | 130 | 180 |
| 4.7 | 320 | 300 | 280 | 240 | 200 | 170 | 140 | 120 | 170 |
| 4.9 | 310 | 290 | 260 | 230 | 190 | 150 | 130 | 110 | 160 |
| 5.1 | 310 | 290 | 260 | 220 | 180 | 130 | 100 | 80 | 150 |
| 5.3 | 300 | 280 | 240 | 210 | 160 | 120 | 90 | 70 | 130 |
| 5.5 | 290 | 270 | 230 | 190 | 140 | 100 | 70 | 60 | 120 |
| 5.7 | 280 | 260 | 220 | 170 | 120 | 90 | 60 | 50 | 100 |
| 5.9 | --- | 240 | 200 | 150 | 100 | 80 | 50 | 40 | 80 |
| 6.1 | --- | --- | 180 | 120 | 80 | 60 | 40 | 40 | 60 |
| 6.3 | --- | --- | --- | 90 | 60 | 40 | 40 | 30 | 40 |

¹ See AGR-1 for limestone rates needed expressed in Tons/Acre.

Table 2. Suggested Application of Ordinary Powdered Sulfur to Reduce the pH of an 8-Inch Layer of Soil, as Indicated in pt/100 sq ft.¹

| Original pH of Soil ² | Pints of sulfur for 100 sq ft to reach pH of | | | | | | | | | |
|----------------------------------|--|-------|-------|-------|-------|-------|-------|------|------|------|
| | 4.5 | | 5.0 | | 5.5 | | 6.0 | | 6.5 | |
| | Sand | Loam | Sand | Loam | Sand | Loam | Sand | Loam | Sand | Loam |
| 5.0 | 2/3 | 2 | --- | --- | --- | --- | --- | --- | --- | --- |
| 5.5 | 1 1/3 | 4 | 2/3 | 2 | --- | --- | --- | --- | --- | --- |
| 6.0 | 2 | 5 1/2 | 1 1/3 | 4 | 2/3 | 2 | --- | --- | --- | --- |
| 6.5 | 2 1/2 | 8 | 2 | 5 1/2 | 1 1/3 | 4 | 2/3 | 2 | --- | --- |
| 7.0 | 3 | 10 | 2 1/2 | 8 | 2 | 5 1/2 | 1 1/3 | 4 | 2/3 | 2 |

¹ Although aluminum sulfate often is recommended to gardeners for increasing the acidity of the soil, it has a toxic salt effect on plants if it is used in large amounts. Small amounts are not very effective. About seven pounds of aluminum sulfate are required to accomplish the same effects as one pound of sulfur.

² Based on water pH value.

Coal ash has little or no liming value. Do not use it on garden soils because it contains a fairly high concentration of heavy metals and other toxic compounds which may be taken up by the plants.

For organic gardeners, only powdered or prilled elemental sulfur can be used for lowering pH, while aluminum sulfate, a synthetic product, is not allowed. Powdered sulfur should take at least one year to oxidize and reduce soil pH, and prilled sulfur will take slightly longer. Organic growers should be conservative in the application of soil sulfur by splitting the total application between the fall and spring as sulfur has both fungicidal and insecticidal action and can detrimentally affect soil biology if overused. Organic gardeners can use any type of agricultural limestone to increase pH.

Preparing a New Garden Site

As soon as the soil is workable in the spring, turn over the sod of a new garden site by plowing, rototilling or hand spading. Prepare the soil at least 8 inches deep. Increase this depth each year until you reach 10 to 12 inches. Do not work the soil when it is very wet because you can damage its structure by compacting it. If the soil crumbles readily rather than sticking together, you can proceed safely.

Continue to work the plot until the coarse, lumpy texture is replaced with a fine, granular one suitable for a seedbed. Do not overwork the soil to a powdery fine condition which will cause surface crusting. After you have appropriately tilled the soil, add organic material and fertilizer as recommended.

If you want raised beds, throw the soil from the paths into 3- to 4-foot-wide beds after adding organic matter and the recommended fertilizer. This extra soil plus the added organic matter will raise the beds a few inches higher. If you like, boards or stones can hold the soil in place. For the last preparation step, rake the soil surface smooth and lay off rows. Now you are ready to plant seeds or set transplants.

Organic Matter

Add organic matter to the soil each spring and fall. You can also add it as mulch during the growing season and as a green manure or cover crop during or after the growing season. Adding organic matter is the most beneficial treatment for improving and maintaining your garden soil. It loosens and improves the drainage and aeration of heavy clay soils while increasing the moisture-holding ability of very light, sandy soils.

Besides helping the soil structurally, organic matter favors a buildup of organisms which in turn helps make available nutrients that were previously held in the soil in unusable forms. The organic matter itself provides nitrogen and other nutrients as it decays.

The type of organic matter you should add will depend on what materials are most available. Some sources are manure, composted leaf mold, grass clippings and pine bark humus. Caution: Do not apply fresh manure with a high nitrogen content in the spring. Rabbit, chicken and sheep manure should be applied in the fall or composted before they are used on the garden. Fresh manure may also contain bacteria that are harmful to humans.

Use of manure in organic systems is allowed with major limitations. Raw manure must always be incorporated into the soil immediately following application and it must be applied 120 days before harvest for all crops. Though the use of raw manure is al-

lowed in organic systems, it is far preferable to properly compost the manure before using it as a soil amendment or fertilizer source.

Commercial Fertilizers

A continuous supply of nutrients is important for producing high yields of quality vegetables. Commercial fertilizers are a convenient and economical way of supplying these nutrients. However, they must be used properly since plants can be damaged by their improper application or excessive use.

Any fertilizer's value can be determined by its analysis in percentage of nitrogen, phosphorus and potassium. Applying fertilizer according to soil test results allows less chance of under- or overfertilization (Table 3).

Table 3. Phosphate, potash, and nitrogen.

| Soil Test Level | Fertilizer (lb/1000 sq ft) | |
|---------------------------------|-------------------------------|------------------|
| | P ₂ O ₅ | K ₂ O |
| High (above 60 P, 300 K) | 0 | 0 - 1 |
| Medium (60 - 30 P, 300 - 200 K) | 1 - 2 | 1 - 2 |
| Low (below 30 P, 200 K) | 3 - 5 | 3 - 5 |

Nitrogen: For a continuously cropped garden where little or no organic matter has been added, apply 2 lb of actual N/1000 sq ft before planting. Following heavy grass sod, apply 3 lb of actual N/1000 sq ft before plowing. Where heavy applications of barnyard manure or compost have been added, apply no nitrogen.

Sometimes simple calculations must be made to determine how much fertilizer to add to a garden. These examples use complete fertilizers. If your soil test indicates only a need for nitrogen, use a high nitrogen fertilizer such as 44-0-0 or 33-0-0 instead of a complete fertilizer such as 5-10-10 or 12-12-12 which will supply more nutrients that you actually need in the garden. Follow these steps:

Step 1: Determine the *amount of nitrogen* needed for your garden.

$$\begin{aligned} & \text{garden size (sq ft)} \\ & \div 1,000 \\ & \times 2 \\ & = \text{lb actual N needed} \end{aligned}$$

Example 1a: The size of your garden is 800 sq ft.
 $(800 \div 1,000) \times 2$
 = **1.6 lb actual N needed**

Example 1b: The size of your garden is 1,475 sq ft.
 $(1,475 \div 1,000) \times 2$
 = **2.95 lb actual N needed**

Step 2: Determine the *amount of fertilizer* needed to supply the nitrogen calculated above.

$$\begin{aligned} & \text{lb actual N needed} \\ & \div \% \text{ N available in the fertilizer} \\ & = \text{lb of fertilizer needed} \end{aligned}$$

Example 2a: The size of your garden is 800 sq ft, so you need to apply 1.6 lb N. The 5-10-10 fertilizer you intend to use contains 5% actual N. Convert 5% to 0.05, and plug in the numbers:
 $1.6 \div 0.05$
 = **32 lb of 5-10-10 needed**

Example 2b: The size of your garden is 1,475 sq ft, so you need to apply 2.95 lb N. The 12-12-12 fertilizer you intend to use contains 12% actual N. Convert 12% to 0.12, and plug in the numbers:
 $2.95 \div 0.12$
 = **24.5 lb of 12-12-12 needed**

Apply the recommended amounts of fertilizer in the spring. Spread the fertilizer evenly over the garden area before plowing or spading, or after plowing and before rototilling or hoeing in preparation for planting.

If you did not have your soil tested (i.e., if you have a very limited garden area), the following amounts may be applied:

- small garden: 4 lb 33-0-0 or 3 lb 44-0-0/1,000 sq ft
- smaller garden: 0.4 lbs (~1/2 cup) 33-0-0 or 3 lb (1/4 cup) 44-0-0/100 sq ft

For container gardens use a complete fertilizer (5-10-10 or 10-10-10) at a rate of 1 oz/bushel (or 2 Tbs/bushel).

This is a modest recommendation and assumes the presence of some available nitrogen in the soil for plant growth. If you use the same soil or area the next year, you should have the soil tested to prevent under- or over-fertilization.

Organic Fertilizers

Commercial organic fertilizers are just as effective as conventional fertilizers in supplying necessary plant nutrients though they are often more expensive, harder to find and often act more slowly than commercial fertilizers. The preferred manner for certified organic growers to address plant nutrition is to start with a soil management plan that includes the extensive use of compost, crop rotation and cover cropping (see pages 20-21). Once the nutrient contributions of applied compost and turned in cover crops are calculated, then commercial organic fertilizers, preferably from a local source, could be used to “fill the gap” between what has been provided and what a future crop may need.

There are many classes of organic fertilizers ranging from concentrated plant material (alfalfa meal, soybean meal), animal slaughter by-products (blood meal, bone meal), fish by-products (liquid fish emulsion), concentrated animal manures (bird guano), rock minerals, and many micro-nutrient sources. The majority of organic fertilizers are not as soluble in water as conventional fertilizers, and thus are not as immediately available for plant uptake. Instead, microorganisms found in the soil must break down or decompose the organic fertilizer before it becomes completely available to plants. The use of the word “organic” on a fertilizer label does not always mean the fertilizer is allowed for certified organic growing purposes due to differing state and federal regulations relating to the use of the word “organic.” Only fertilizer labels that include the words “certified organic” or those fertilizers tested and labeled by the *Organic Materials Review Institute* (OMRI) are truly allowed for use on a certified organic farm or garden.

Crop Rotation

As you continue your vegetable garden from year to year, try to avoid planting the same or closely related crops in exactly the same spot more than once every three years. Rotation helps prevent insect and disease buildups. The vegetables listed together below are subject to the same disease and insect problems.

- chives, garlic, leeks, onions, shallots
- beets, Swiss chard, spinach
- cabbage, cauliflower, kale, collards, Brussels sprouts, broccoli, kohlrabi, turnips, rutabaga, Chinese cabbage, mustard
- peas, broad beans, snap beans, lima beans

- carrots, parsley, celery, celeriac, parsnip
- potatoes, eggplant, tomatoes, peppers
- pumpkins, squash, watermelons, cucumbers, muskmelons
- endive, salsify, lettuce

In addition, root and bulb crops are susceptible to many of the same soil pests so try to rotate these every year.

Pest Control

The goal of many home gardeners is to apply few or no pesticides. This philosophy often results in unacceptable harvests because the gardener is often faced with a dilemma of either applying pesticides or experiencing a significant or total crop loss. While it is difficult to achieve consistent harvests from your garden without some strategy for pest control, the following principles may help you use pesticides more sparingly and still achieve acceptable results.

Pest-resistant crops—Cultivars of some vegetable crops are genetically resistant to certain pests. By choosing these cultivars, the gardener increases their chances of avoiding problems with specific pests. An extensive list of vegetable cultivars, including information regarding their genetic resistance to specific pests, can be found in ID-133, *Vegetable Cultivars for Kentucky Gardens* (<http://www2.ca.uky.edu/agc/pubs/id/id133/id133.pdf>). The gardener should be aware that there are no “super” cultivars able to resist all known pests and that some pest control may still be needed to ensure a harvest. But using resistant cultivars should lessen the need for pesticides.

Spacing and sun exposure—Avoid crowding plants together in the garden. Crowded plants grow poorly and may become more susceptible to pests. There is also less air movement through crowded plants that may result in increased problems with disease. Garden plants are generally adapted to growth in full sun. Trying to garden in a shady backyard may result in weak, unproductive plants that are more susceptible to pests. Try to ensure that your garden receives at least six hours of direct sunlight each day.

Cultural practices—Make sure plants have adequate water and nutrition. Both over- and under-watering or fertilizing plants may enhance pest problems. Proper watering and fertilizing techniques were covered in the first part of this publication. Also ensure that you clean up the garden once a crop has finished or the season had ended. Many pests overwinter or continue their lifecycles on residue from the previous crop. Destroy or thoroughly compost (better to destroy if a pest infestation is evident) crop residue once harvest is complete. Also consider rotating crops that may be susceptible to soil-borne pests—see “Crop Rotation” on this page.

Scout for problems—Spy before you spray! Most home gardeners are keenly aware of what’s going on in their gardens. As you check germination of newly planted seeds, monitor development of vegetables, and harvest ripe fruit, look for problems. If you do see problems, are you confident in your ability to diagnose them correctly? For help with diagnosis, consult other parts of this publication, gardening books, or your local county extension office (detailed photos or samples of the problem will aid the diagnosis). A correct diagnosis is key to successful pest management or control.

Planting

General Considerations

Buying Seed

Buy fresh, high quality seed from a local seed store, garden center or mail order seed catalog for your vegetable garden. Using seed from the previous year's plants is generally not recommended for the beginning gardener since such seed may not germinate well or may not breed true. You can refrigerate commercial seed in a glass jar with something to dry it (for instance, powdered milk). The seed can then be used later.

Planting

The soil should be moist at planting time but not overly wet. To test for moisture content, squeeze together a handful of soil. If it crumbles readily rather than sticking together, proceed with planting. Drop vegetable seed into furrows in continuous rows. To make straight rows, drive stakes at each end of the garden and pull a string taut between them. Then draw a hoe or rake handle along the string to make a shallow ½-inch furrow for fine seed. Use the corner of the hoe blade to make a deeper 1-inch furrow for larger seed. Measure the distances between rows with a yardstick.

Empty seeds into your hand and drop them from between your fingers. Mix dry, pulverized soil or sand with very small seeds to make even distribution easier. Plant the seed more thickly than needed in case some do not germinate. Cover the seeds and firm the soil lightly over them using the bottom of a hoe blade.

Some seeds, like carrot and parsley, take a long time to germinate—often three to four weeks. If the seeds dry out during germination the seedlings will die, so be sure to keep these rows moistened. You can also put a board or a strip of plastic or burlap over the row to give the seedlings a warm, moist greenhouse environment. Remove this cover just after the seedlings emerge.

Thinning

After germination, you'll need to thin the seedlings to correct their spacing. When your plants have two or three leaves, pull up the weakest ones or pinch off the tops, leaving the rest of the plants spaced correctly (see Table 4).

The soil should be moist when you thin so you do not injure the remaining plants in the process. Do not wait for the plants to become overcrowded before thinning. With some vegetables, thin-

Figure 4. A large tray can be sectioned into rows using a ruler or similar sharp-edged instrument. Once seeds are sown in the "furrows," cover the seeds with a growing medium using a blunt instrument or your hand.

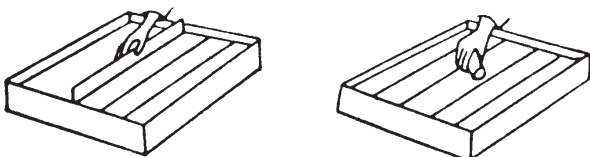
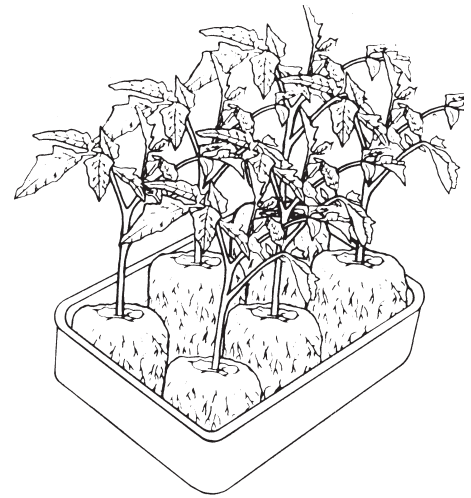
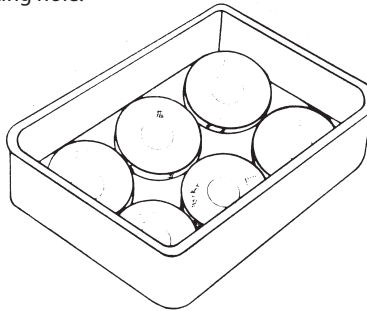

Figure 5. Compressed peat pellets make plant growing easy. After you add water to the compressed pellet, it will expand up to seven times its original size. Place seed into the open end for germination. The pellet can be placed directly into the planting hole.



ning can be at harvest. Beet and turnip thinnings make excellent greens. Radishes, onions and lettuce can be left to thin until some are big enough to eat.

Transplants

Why Grow Your Own Transplants?

Having the varieties you want when you want to plant them—that's the great advantage of growing your own transplants.

The flip side of that coin is quality. If you can't provide good growing conditions, particularly plenty of bright light for growing seedlings, the quality of your homegrown plants may not be all you desire.

The big advantage of growing transplants yourself is the wide choice of varieties available in seed. People who produce transplants commercially tend to concentrate on a few popular varieties of each crop. Seed catalogs offer a much wider selection.

If you plant the seeds at the appropriate time and the seedlings grow well for you, you can have transplants that are just the right size for planting in the garden at just the right time. You can have cool-weather crops like broccoli and kohlrabi to plant early in the spring and again in midsummer for a fall crop. And you can have warm-weather crops like tomatoes for planting after the danger of frost is past.

Materials

You can successfully grow vegetable transplants indoors or outdoors if you use a suitable growing structure. While a greenhouse is not essential, being able to control temperature, light, moisture and ventilation is crucial. Day temperatures should be between 60° to 65°F for warm-season crops. Keep the soil moist but not soggy.

You can buy all the materials you need for starting transplants under different brand names from local garden supply centers or through seed and garden supply catalogs. Plant starting kits containing all the necessary equipment are also available. Some have the seed already planted; you only need to add water and put them in a suitable growing area.

Fertilize the plants when the second true leaves appear. Use a liquid fertilizer, such as 20-20-20 or liquid fish emulsion, at rates recommended on the package. Fertilize again in another week or two.

Pots made of peat are good for growing transplants, because plant roots can easily grow through the sides. Do not remove the peat pot when you transplant, and it will gradually decompose. Keeping the plants in the same container reduces transplant shock and helps produce crops a few days earlier than scheduled. You can use egg cartons and paper cups, but be sure to punch holes in the bottoms for good water drainage. Also, cut away these containers before transplanting. Put individual pots in plastic, metal or wooden trays for growing and for convenience when you water and handle them.

Growing Transplants Indoors

For indoor growing, sow seeds in a plant tray containing an artificial growing medium of peat moss and perlite available at garden centers. Adding compost to the potting media at up to 25% of total volume can reduce the need for fertilizers later and potentially encourage seed germination. Enclose the seeded trays in a plastic bag and keep them at room temperature until seedlings begin to emerge. Then, remove the plastic and transfer the trays to suitable growing areas.

The average windowsill is one location for growing plants, but it usually does not get enough light. So, you have to use artificial light to supplement. Use cool white fluorescent lamps alone, a mixture of cool white and warm white fluorescent lamps, or a mixture of cool white and plant growth fluorescent lamps. Locate the lamps 5 to 10 inches from the foliage and operate them 12 to 18 hours/day. Be sure to keep seedlings cool enough (60° to 65°F) for strong, sturdy growth after they germinate.

Plants should be “hardened off” about two weeks before planting them in the garden. That is, you toughen the plants so that they can withstand the outside environment. To do so, begin exposing them to lower temperatures. One way is to take your transplants outside in the daytime and bring them in at night. However, don’t let them get caught in a frost. Reduce your watering and fertilizing of transplants to help “hardening off” about one week before transplanting. Do not let them dry out and wilt, however.

Growing Transplants Outdoors

Structures used for growing transplants outdoors may or may not be artificially heated.

The cold frame for housing transplants receives no artificial heat. Use the sun to its greatest advantage by locating these structures on the south side of a building. Cold frames are used for holding or “hardening off” transplants.

The hotbed is a cold frame structure which includes an additional source of heat. Heat may be supplied from fermenting horse manure, electric cable or light bulbs. Transplants are usually grown in pots set over a 2- to 4-inch layer of composted soil or sand. If horse manure is used or if plants are grown in the bed rather than in pots, use a 4-inch layer of compost as a base. If electricity is the heat source, only a few inches of sand are required for

Table 4. Use this vegetable planting guide to plant vegetables the right way.

| Vegetable | Number of Transplants or Seeds per Foot | Distance Between: | | Planting Depth (in) |
|---------------------|---|--|-----------|---------------------|
| | | Plants When Thinned or Transplanted (in) | Rows (in) | |
| Asparagus | 1 crown | 18 | 30 | 6-8 |
| Beans, bush, lima | 6-8 seeds | 4-5 | 30 | 1-1 ½ |
| Beans, bush, snap | 8 seeds | 2-3 | 30 | 1-1 ½ |
| Beets | 10 seeds | 2-3 | 18 | ¼-½ |
| Broccoli | 1 transplant | 14-18 | 30 | |
| Brussels sprouts | 1 transplant per 2 ft | 24 | 36 | |
| Cabbage | 1 transplant | 9-18 | 30 | |
| Carrots | 15-20 seeds | 2-3 | 18 | ¼ |
| Cauliflower | 1 transplant | 16-18 | 30 | |
| Celery | 2 transplants | 6-8 | 30 | |
| Chard | 8-10 seeds | 6-8 | 30 | ¼-½ |
| Chinese cabbage | 4-6 seeds | 12-15 | 24-30 | ¼-½ |
| Collards | 8-10 seeds | 2-4 | 24 | ¼-½ |
| Cucumbers | 4-5 seeds | 24-36 | 30 | ½-1 |
| Eggplant | 1 transplant | 18 | 30 | |
| Endive | 4-6 seeds | 9-12 | 18-30 | ½ |
| Garlic, from cloves | 1 clove | 6 | 12-18 | 1 ½ |
| Horseradish | 1 root | 18 | 30 | 2 |
| Kale | 4-6 seeds | 8-12 | 24-30 | ¼-½ |
| Kohlrabi | 6-8 seeds | 3-6 | 18-30 | ¼-½ |
| Leeks | 10-15 seeds | 3-4 | 20 | ½ |
| Lettuce, head | 1 transplant | 12-18 | 20 | ¼ |
| Lettuce, leaf | 20-30 seeds | ½ | 8-12 | ¼ |
| Muskmelons | 2-3 seeds | 24-36 | 60 | ½-¾ |
| Mustard | 20 seeds | 3 | 18 | ¼ |
| New Zealand spinach | 4-6 seeds | 12 | 30 | ½ |
| Okra | 3 seeds | 12 | 30 | 1 |
| Onions, from seed | 10-15 seeds | 4 | 12-18 | ¼-½ |
| Onions | 3-6 sets | 4 | 12-18 | 1-2 |
| Parsley | 10-15 seeds | 4-6 | 12-18 | ¼-½ |
| Parsnips | 12 seeds | 2-3 | 18 | ½-¾ |
| Peas | 15 seeds | Do not thin | 30-48 | 1 |
| Peppers | 1 transplant | 14-18 | 30-36 | |
| Potatoes | 1 seed piece | 10-12 | 36 | 3-5 |
| Pumpkins | 1-2 seeds | 4 ft | 8-12 ft | 1 |
| Radishes, spring | 10-15 seeds | 2-3 | 12 | ¼ |
| Radishes, winter | 10-15 seeds | 2-4 | 12 | ¼ |
| Rhubarb | 1 crown per 2 ft | 36 | 4-5 ft | |
| Rutabaga | 4-6 seeds | 6-8 | 18-30 | ½ |
| Southern pea | 3-4 seeds | 2-3 | 30 | |
| Spinach | 6 seeds | 4-6 | 12-18 | ¼ |
| Squash, summer | 2-3 seeds in hill | 24 | 48 | 1 |
| Squash, winter | 1-2 seeds | 48 | 6-8 ft | 1 |
| Sweet corn | 2 seeds | 8-10 | 30 | 1-2 |
| Sweet potatoes | 1 slip | 15 | 36 | |
| Tomatoes | 1 transplant per 2 ft | 24 | 36 | |
| Turnips (roots) | 6-8 seeds | 3-4 | 12-15 | ½ |
| Turnips (greens) | 10-12 seeds | 2-3 | 12-15 | ½ |
| Watermelons | 2-3 seeds in hill | 6-8 ft | 72 | 1 |

a base, and transplants like cabbage, cauliflower, broccoli and lettuce may be sown directly in the composted soil base.

Buying Healthy Transplants— A Good Investment

Sometimes what appears to be a good buy because it’s inexpensive may turn out to be a poor investment in transplants. Transplants which were seeded at the right time and were grown at the right temperature, in abundant light and adequate moisture, will be compact, with the distance between leaves very small (Table 5). The stems will be pencil thick and rigid. Leaves will be dark

Table 5. Transplant production data.

| Crop | Weeks from Seeding to Transplanting ⁴ | Average Seedling Date | Seed Depth (in) | Seed Spacing | | Soil Temp. (°F) Needed for Seeds to Germinate | Average Days to Emerge | Satisfactory Growth Temp. | |
|------------------------------------|--|-----------------------|-----------------|---------------------------------------|-----------------|---|------------------------|---------------------------|------------|
| | | | | Seeds/Inch | Rows Apart (in) | | | Day (°F) | Night (°F) |
| Cool Season¹ | | | | | | | | | |
| Broccoli ² | 5-7 | Feb 5, July 1 | ¼ | 8 | 2 | 80 | 4-6 | 65 | 60 |
| Brussels Sprouts | 5-7 | Feb. 5, July 1 | ¼ | 8 | 2 | 80 | 4-6 | 65 | 60 |
| Cabbage | 5-7 | Jan. 20, July 1 | ¼ | 10 | 2 | 85 | 3-5 | 55 | 50 |
| Cauliflower ² | 5-7 | Jan. 25, July 1 | ¼ | 8 | 2 | 80 | 4-6 | 65 | 60 |
| Lettuce | 5-7 | | ¼ | -- | 2 | 75 | 2-3 | 60 | 50 |
| Onion | 10-12 | | ¼ | -- | 2 | 75 | 4-5 | 65 | 55 |
| Warm Season | | | | | | | | | |
| Cucumber ³ | 3-4 | April 1 | 1 | 2 seeds per 4" x 4" pot, thinned to 1 | | 95 | 3-6 | 75 | 70 |
| Muskmelon ³ | 3-4 | April 1 | 1 | | | 90 | 4-6 | 75 | 70 |
| Squash ³ | 3-4 | April 1 | 1 | | | 95 | 5-7 | 75 | 70 |
| Watermelon ³ (seeded) | 4-6 | Mar. 25 | 1 | | | 85 | 4-6 | 75 | 70 |
| Watermelon ³ (seedless) | 4-6 | Mar. 25 | 1 | | | 90 | 4-6 | 75 | 70 |
| Tomato | 4-7 | Mar. 15 | ½ | 10 | 2 | 80 | 7-9 | 70 | 60 |
| Eggplant | 6-8 | Mar. 10 | ¼ | 10 | 3 | 80 | 7-9 | 75 | 70 |
| Pepper | 6-8 | Mar. 10 | ¼ | 10 | 2 | 80 | 8-10 | 70 | 65 |

¹ Cool-season crops are frost tolerant and can be set in the garden before the last frost. Warm-season crops are susceptible to frost and should not be set until the danger of the last frost is past.

² Do not allow broccoli or cauliflower to become deficient in nitrogen or water or exposed to cold temperatures when they are small.

³ Seed into individual containers (peat) that may be placed directly into the soil, because these crops will not tolerate root disturbance.

⁴ Allow an extra two weeks growing time if grown in plant beds.

green, large and upright with no tendency to droop. Transplants that are trying to produce flowers or fruit are not as desirable as those which are strictly vegetative. Plants trying to produce fruit are slow to develop good root systems to support later fruit production.

Bare root plants will be slower to establish than transplants grown in cell packs or containers. Sometimes, plants are packed in large bundles and shipped great distances. To save space, these plants are clipped before shipping to reduce the amount of top growth. This is a poor practice since it not only induces transplant shock and delays fruiting but spreads disease as well.

When purchasing transplants, be sure to ask whether the plants have been hardened off. If not, it is important to place them in a cool spot and reduce water for a couple of days to acclimate the plants to outside conditions.

Moving Transplants to the Garden

Whether you buy plants or grow your own, the time comes to plant them outside.

Transplanting gives a plant more space to develop, but it will temporarily check growth, not stimulate it. Therefore, for successful transplanting, try to interrupt plant growth as little as possible. In doing so, peat pots give you an advantage, even though they are expensive, because they do not have to be removed. Follow these eight steps when transplanting:

1. Transplant on a shady day in late afternoon or in early evening to prevent wilting.
2. Soak transplants' roots thoroughly an hour or two before setting them in the garden.

Figure 6. Cold frame. Scrap lumber can be used to build the basic frame. The hinged top can be made from old windows or a frame covered with clear plastic.

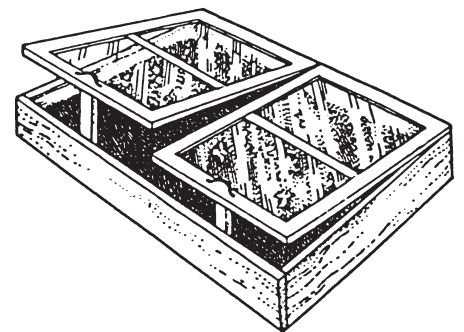

3. Handle the plants carefully. Avoid disturbing the roots.
4. Dig a hole large enough to hold the roots. Set the plants to the lowest leaf at recommended spacings. Press soil firmly around the roots.
5. Pour 1 cup of starter solution in the hole around the plant. Starter solutions are high analysis fertilizer solutions for rapid transplant root development. To prepare, mix plant food with 15-30-15, 10-53-17 or 20-20-20 analysis at the rate of 2 Tbs/gallon of water. Any liquid organic fertilizer, like fish emulsion, can also be used as a started solution by following the recommendations on the package.
6. Put more soil around each plant, but leave a slight depression for water to collect. Break off any exposed parts of peat pots so that they will not act as wicks and pull water out of the soil.
7. Shade the plants for a few days after transplanting on a very hot day by putting newspapers or cardboard on their south sides.
8. Water the plants once or twice during the next week.

Growing More with Less Space

Intensive Gardening

Conventional gardens, planted in rows about 3 feet apart, have been popular for many years because they can be planted and easily cultivated with a farm tractor or a rototiller. However, because of the wide spaces between rows, such gardens are not very space efficient. Gardeners with limited land area may want to plan an intensive garden.

Intensive gardens employ space-saving techniques such as wide-row planting, raised beds, intercropping, succession planting, vertical training and planting in stairstep arrangements. Extending the growing season using plant protectors is another technique of intensive gardening. Lettuce, radishes and other cool-season crops can be grown early in the spring or late in the fall with such protection.

Keep in mind that some intensive techniques may require more time, labor and money than conventional techniques. Also, closely spaced plants use more water than widely spaced plants, and competition for water may reduce yields during times of drought.

In wide-row planting, vegetables are planted in wide rows between narrow pathways as opposed to single rows with wide spaces between the rows. The vegetables are spaced so that they will just touch one another at maturity. This method of gardening may reduce weed problems, although hand weeding will be more difficult. Since less soil remains bare than in conventional gardens, usually less erosion occurs.

Be aware that vegetables prone to certain diseases should not be planted too intensively. Tomatoes, for example, will suffer less from disease if moving air dries their leaves. When placed too closely, plant leaves retain moisture longer, and disease organisms thrive and are easily spread from plant to plant.

Raised Beds

Raised beds increase production by conditioning the soil for excellent root development. In an area 3 to 4 feet wide, you loosen the soil and mix it with organic matter and fertilizer (see "Preparing the Soil"). Then, once you've constructed the raised beds and permanent paths between the beds, you no longer disturb the soil. Combining raised beds with other intensive practices such as wide-row planting, intercropping or succession planting gives the greatest yields in a garden. In addition, the excellent drainage in raised beds often permits early planting, though raised beds also will dry out faster than level ground later in the season. Use mulches to retain moisture in your raised beds.

Intercropping

Intercropping involves planting different vegetables side by side to take advantage of the different times of maturity, heights, spreads or rooting depths.

- A classic example of intercropping involves corn, beans and squash. A few weeks after sowing corn seeds, you plant pole beans close to the corn rows to use the corn stalks for support.
- As another example, you can set tomato transplants between lettuce plants; the lettuce matures and is harvested before the tomato plants grow very large.

Figure 7. Raised bed.

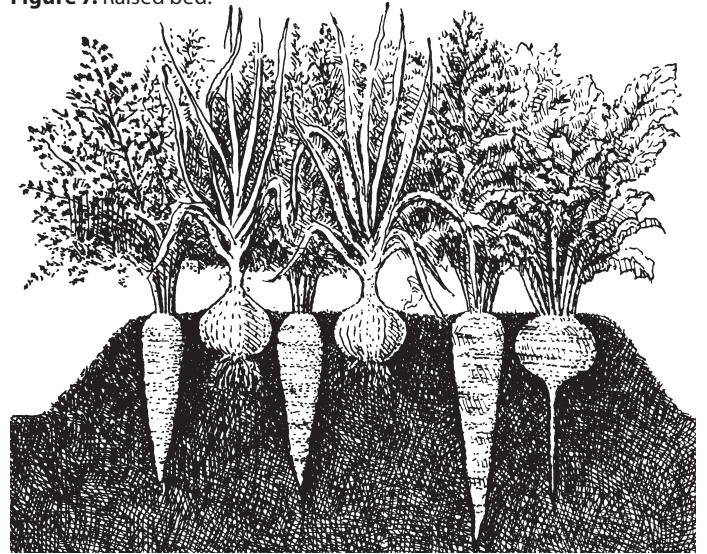

- Also, try sowing radish seeds with carrot seeds. The radishes germinate quickly, marking the row of slowly sprouting carrots. Radishes are harvested within a few weeks, long before they interfere with the carrots.

Many other intercropping ideas will develop from your own gardening experience. Remember, however, that yields of certain vegetables may be reduced when crowded.

Succession Planting

In succession planting, another seed or transplant immediately takes the place of a harvested plant. For example, when you harvest a lettuce plant in early summer, a Swiss chard or New Zealand spinach transplant can replace it. After harvesting an early crop of sweet corn, you might follow with a fall crop of broccoli, spinach or snow peas.

Vertical Training

Vertical training involves growing plants upright rather than horizontally. You can vertically grow vine crops, tomatoes, peas and beans on wood, wire or string trellises, or in cages. Besides having more plants per square foot, you will also have cleaner fruit that will be easier to harvest.

Stairstep

The stairstep arrangement is a form of vertical planting that lends itself especially well to small plants, such as lettuce, spinach and onions. Basically, stairsteps change a two-dimensional space into a three-dimensional one, usually with wooden bins in pyramid shapes. You can also use metal strips, small stone walls, bricks or concrete blocks to hold the soil in place. As with raised beds, you will need to pay careful attention to watering of plants grown in such arrangements.

Container Gardening

Even if you live in an apartment or condominium with only a balcony, patio or walkway available for gardening, you can still enjoy many of the rewards of vegetable gardening.

Container gardening can provide you with fresh vegetables as well as recreation and exercise. Many container-grown vegetables also have ornamental value and can enhance your home. Using containers allows you to take advantage of the various microclimates in your vicinity. For example, lettuce can be grown in a cool, shaded area while heat-loving plants, such as eggplant, can be located in full sun where reflections from buildings or patio surfaces add to the heat.

Feeding and watering plants is easier if you use big containers, since small ones need more frequent attention. Choose the container size to match the plant's growth requirements.

Choosing Vegetables for Containers

As a rule nearly all leafy vegetables will do well in containers. Plant breeders have developed many dwarf or miniature varieties for container production.

Crops with many fruits per plant such as tomatoes are good choices. Table 9 lists some of the vegetables and their requirements for container production.

A 12" x 48" x 8" box makes an excellent patio herb garden. Chives, garden thyme, basil, marjoram and summer savory will all do well in such a planter box. The sprawling growth habit of the various mints, oregano and rosemary make them attractive in hanging baskets. Typical container sizes are listed in Table 6.

Containers

Material—You can use containers made of clay, wood (redwood or cedar), plastic or metal for growing vegetables. Also consider using barrels, flower pots or window boxes. Unusual containers will add interest to your garden.

Holes—Each container must have drainage holes in the bottom so the plant roots will not stand in water. If the container does not already have holes, make at least four small nail holes in its sides, ½ inch from the bottom.

Size—The container should be the proper size for the plant growing in it (see Table 8 for types and sizes of growing containers).

Planting in Containers

Some vegetable seeds are planted directly in the containers where they will be growing. Others are set in as transplants.

Use a commercially prepared greenhouse soil mix, available at local garden centers or greenhouses, to grow plants in containers. If you're going to have several large containers, you may want to mix your own soil. The soil mix (Table 7) is good for container gardening because it is lightweight and sterile.

Table 6. Typical container dimensions, and their corresponding size in gallons.

| Inches | Gallons |
|-------------|---------|
| 7 ¼" x 6 ¼" | 1 |
| 8" x 8" | 2 |
| 10" x 10" | 3 |
| 12" x 11" | 4 |
| 12" x 12" | 5 |
| 13" x 13" | 6 |

Table 7. Soil mix for container plants.

| |
|---|
| 1 part composted or sterilized ¹ garden soil |
| 1 part sphagnum peat moss (Canadian) |
| 1 part perlite |
| ½ cup dolomitic limestone/bushel |
| ¼ cup superphosphate/bushel |

¹ To sterilize, put moistened soil in a cake pan and heat at 200°F for 46 - 60 minutes, or put in a glass pan in a microwave oven for 15 - 20 seconds.

Planting Procedure

Moisten the soil mix the day before you intend to plant for best results. Many mixes contain a high percentage of peat, which requires time to soak up water. Peat moistens faster with hot water than with cold water. A drop of dishwashing soap will help wet dry potting mixes.

- Fill a clean container to within ½ inch of the top with the mixture.
- Follow the seed package's instructions for planting.
- Sow the seed more thickly than needed in case some do not germinate.
- Put a label with the name and variety of the vegetable and the date of planting in each container.
- Water the seed gently with a watering can after sowing, being careful not to wash out the seed. Or, put a burlap bag over the container to reduce water impact.
- Thin the plants for proper spacing when they have two or three leaves.

Care

Pay particular attention to watering container vegetables. Container soils can dry out very quickly, especially on a concrete patio in full sun. Daily watering may be necessary. Water when the soil feels dry. However, do not go to extremes. The soil should not be soggy or have water standing on top of it. Apply water until it runs out the drainage holes.

Protect plants from very high heat caused by light reflection from pavement or a building. If necessary, move them to a cooler spot or shade them during the hottest part of the day. Plants may also need to be taken to a more sheltered location during severe rain or wind storms.

Vegetables grown in containers should be fertilized regularly. Make the first application three weeks after the plants have two sets of leaves. Repeat once a week, using a soluble plant food at one-half strength (according to label directions).

Keep a close watch for insects and diseases which may attack vegetables. Identify any problems and take appropriate control measures.

After you harvest spring and early summer crops, replant the containers with vegetables for the summer or fall garden.

Mini-Gardens

Another solution to working with limited space is to plant several mini-gardens in vacant spots around your yard instead of putting all your vegetables in one plot. Some possible sites are near the kitchen door, along the sunny side of the house or garage, around the outdoor grill, along a walk in a flower bed or along a fence. Placed this way, vegetables serve a dual purpose as both food and landscape plants.

Table 8. Types and sizes of growing containers.

| Type | Dia. | Hgt. | Vol. |
|-----------------|-------|-------|---------|
| 2 inch pot | 2" | 3 ½" | 1 pt |
| 6 inch pot | 6" | 5 ½" | 3 pt |
| No. 10 can | 6" | 7" | 3 qt |
| 8 inch planter | 8" | 8" | 1 ½ gal |
| 10 inch planter | 10" | 9" | 2 ½ gal |
| ½ bushel basket | 13" | 9 ½" | 4 gal |
| 5 gal can | 11" | 12 ½" | 5 gal |
| 1 bushel basket | 17 ½" | 11 ½" | 8 gal |

Table 9. Container vegetable recommendations.

| Season/ Light Req. | Spacing/ Container Size | Varieties | Days until Harvest |
|--|--|-----------------------------------|--------------------------|
| Bean (green, bush type) | | | |
| Warm Full sun | 5 - 6" apart 8 - 10" deep | Romano Bush | 50 |
| | | Blue Lake Bush | 58 |
| | | Tendercrop | 54 |
| Beets | | | |
| Cool Tolerates partial shade | 2 - 3" apart 24" x 36" x 8" | Kestrel | 53 |
| | | Red Ace | 53 |
| | | Merlin | 55 |
| | | Detroit Supreme | 59 |
| Broccoli | | | |
| Cool Full sun | 15" apart 12" x 48" x 8" | Green Comet | 55 |
| | | Emperor | 60 |
| Cabbage | | | |
| Cool Full sun | 12 - 24" apart 10" deep | Fast Vantage | 65 |
| | | Stonehead | 70 |
| | | Market Prize | 76 |
| | | Super Red 80 | 82 |
| Carrots | | | |
| Spring, Fall Partial shade | 1½ - 3" apart 24" x 36" x 10" | Ya Ya | 56 |
| | | Sugarsnax | 68 |
| | | Little Fingers | 65 |
| | | | |
| Collards | | | |
| Cool, Fall Full sun | 6" apart 8 - 10" deep | Champion | 60 |
| | | Georgia/Southern | 80 |
| | | Vates | 80 |
| Cucumbers | | | |
| Warm Full sun | 12 - 16" apart 12" x 48" x 8" | Sweet Success | 55 |
| | | Sweet Burpless Hybrid | 55 |
| Eggplant | | | |
| Warm Full sun | 1 per 4 - 5 gal container | Orient Express (Japanese type) | 58 |
| | | Dusky | 61 |
| | | Blackbell | 70 |
| | | 12" apart 10 - 12" deep | Fairy Tale |
| Kale | | | |
| Cool, Fall Partial shade | 6" apart 12" x 48" x 8" | Dwarf Blue Curled | 55 |
| | | Vates | 57 |
| Lettuce | | | |
| Early spring, Fall Partial shade | 4 - 6" apart, leaf; 10" apart, head 12" x 48" x 8" | Kentucky Bibb | 54 |
| | | Buttercrunch | 75 |
| | | Royal Oakleaf | 50 |
| | | Red Sails | 45 |
| | | Burpee's Iceburg | 85 |
| Onions (bulb)¹ | | | |
| Early spring Partial shade | 2" apart 6" deep | Walla Walla Sweet | |
| | | Candy | |
| Onions (green) | | | |
| Early spring or September Full sun | 2" apart 6" deep | White Spanish Bunching (early) | |

continued

Table 9. (continued)

| Season/ Light Req. | Spacing/ Container Size | Varieties | Days until Harvest |
|--|---------------------------------------|-----------------------------------|--------------------------|
| Peas | | | |
| Cool Full sun | 4 - 6" apart 8 - 10" deep | Little Marvel | 62 |
| | | Sugar Ann | 55 |
| | | Cascadia | 58 |
| Peppers | | | |
| Warm Full sun | 14 - 18" apart ½ - 4 gal | Carmen | 75 |
| | | King Arthur | 59 |
| | | Gypsy Hybrid | 65 |
| | | Hot Anaheim | 77 |
| | | Hungarian Wax | 65 |
| | | Jalapeno | 65 |
| Radishes | | | |
| Early spring, Fall Full sun to light shade | 1" apart Any size, 6" deep | Cherriette | 26 |
| | | Cherry Belle | 30 |
| | | Icicle | 28 |
| | | Cherry Bomb | 25 |
| Spinach | | | |
| Spring, Fall Full sun to light shade | 5" apart Any size, 6" deep | Tyee | 42 |
| | | Melody | 43 |
| | | Bloomsdale Long- Standing | 48 |
| Summer Squash | | | |
| Warm Full Sun | 1 per 5 gal container | Black Magic (green zucchini) | 44 |
| | | Gold Rush (yellow zucchini) | 50 |
| | | Burpee Hybrid (green zucchini) | 50 |
| | | Sunburst (yellow scallop) | 52 |
| | | | |
| Swiss Chard | | | |
| Spring, Summer, Fall Partial shade | 4 - 5" apart Any size, 6 - 8" deep | Bright Lights | 55 |
| | | Rhubarb Chard | 60 |
| | | Fordhook Giant | 60 |
| Tomatoes² | | | |
| Warm Full sun, at least 6 hrs/day | 1 per 4 - 5 gal container | Lizzano | 65 |
| | | Terenzo | 56 |
| | | Tumbler | 49 |
| | | Superb Super Bush | 75 |
| Turnips | | | |
| Cool Partial shade | 3 - 4" apart 24" x 36" x 8" | Hakurei | 38 |
| | | Purpletop Globe | 55 |
| | | Seven Top | 42 |
| Zucchini | | | |
| Warm Full sun | 1 per 5 gal container | Spineless Perfec- tion (green) | 45 |
| | | Golden Glory (yel- low) | 50 |
| | | Ambassador (green) | 47 |

¹ In spring, plant long day variety; in fall, plant short day variety.

² Two plantings, one in mid to late April and the other in mid to late June, will extend the tomato harvest over a longer season. Transplants should be started four to seven weeks before planting time. Containers may be moved inside to protect plants from early or late season frosts.

One Garden Plot: Three Garden Seasons

The Spring Garden

The spring garden contains cool-season crops that are planted and harvested from late winter to late spring. The seed of some of these crops can be planted directly in the garden soil, while others will need to be started in a greenhouse or other suitable growing area and then transplanted to the garden (Table 10).

Spring garden plants grow best with relatively cool air temperatures (50° to 65°F) and are raised either for their leaves, stems or flower buds. Peas are grown for their immature fruits. These crops produce their vegetative growth during spring's short, cool days. If they are planted too late in the spring, summer heat reduces their quality by forcing some to flower and form seeds (bolt), and others to develop off flavors, bitterness, poor texture and low yields.

Avoid these problems by planting spring vegetables as soon as the soil can be worked in the spring since light frost will not injure them. Plant either seeds or transplants, allowing the vegetables to reach edible maturity before hot summer days arrive.

Plant as soon as the soil is workable and dry enough so it does not form wet clods. Do not work the soil when it is wet. Doing so can ruin the texture for several years. Wait for the best conditions no matter how much the planting bug is nibbling at your fingers.

Do not use organic mulches in early spring. Rather, let as much sunlight as possible reach the soil to warm it. After May 1, you can use mulches to conserve soil moisture and help prevent weeds.

Plant spring garden crops together so that you can plant fall vegetables in the same area later. When "double cropping," do not plant closely related vegetables in the same rows because of possible disease and insect carryover from the spring crop.

The Summer Garden

As the harvest from your spring garden ends, the summer garden's crops should begin to produce. With careful planning you should have a continuous harvest of fresh garden vegetables.

Your summer garden should have a variety of crops, some harvested during the summer months, and others continuing to bear into fall (Table 11). Generally, summer crops are planted during the cool days of late spring through the warmer days when the danger of frost is past. Summer garden vegetables consist of:

1. Cool-season crops seeded or transplanted before the danger of frost is past, but able to endure hot weather at harvest times.
2. Warm-season crops seeded or transplanted after the frost-free date. This later planting prevents both slow germination from cool conditions and frost injury to emerging plants. Warm-season crops require warm soil and air temperatures for vegetative growth and fruiting. Their quality is enhanced by long, warm days and mild nights.

Since crops vary in how much time they need to reach edible maturity, the summer garden should include short-, mid- and long-season crops.

Table 10. Crops for the spring garden.

| Vegetable | Seeds | Transplants | Days to Maturity ¹ |
|-----------------------|-------|-------------|-------------------------------|
| Beets | x | | 55-60 |
| Bibb lettuce | x | x | 60-80 |
| Broccoli | | x | 40-90 |
| Brussels sprouts | | x | 80-90 |
| Cabbage | | x | 60-100 |
| Carrots | x | | 60-80 |
| Cauliflower | | x | 50-100 |
| Celery | | x | 100-130 |
| Chinese cabbage | x | x | 43-75 |
| Collards | x | | 75-90 |
| Endive | x | x | 60-90 |
| Kale | x | x | 50-60 |
| Kohlrabi | x | | 50-70 |
| Leaf lettuce | x | x | 40-50 |
| Mustard greens | x | | 35-60 |
| Onions ² | x | x | 40-120 |
| Peas | x | | 60-80 |
| Potatoes ³ | | | 90-140 |
| Radishes | x | | 20-30 |
| Spinach | x | | 40-70 |
| Swiss chard | x | x | 55-60 |
| Turnips | x | | 40-60 |
| Turnip greens | x | | 30-50 |

¹ Days given are for the early to late varieties.

² Onions are also available in sets.

³ Potatoes are available as seed pieces.

Table 11. Crops for the summer garden.

| Vegetable | Frost-resistant | Seeds | Transplants | Days to Maturity ¹ |
|-----------------------------|-----------------|-------|-------------|-------------------------------|
| Beets | x | x | | 55-60 |
| Cabbage | x | | x | 60-100 |
| Carrots | x | x | | 60-80 |
| Collards | x | x | | 75-90 |
| Cucumbers | | x | x | 45-65 |
| Eggplant | | | x | 60-75 |
| Endive | x | x | x | 50-60 |
| Green beans, bush | | x | | 50-60 |
| Green beans, pole | | x | | 60-90 |
| Irish potatoes ² | | | | 90-140 |
| Kale | x | x | | 50-60 |
| Leaf lettuce | x | x | | 40-50 |
| Lima beans, bush | | x | | 65-80 |
| Lima beans, pole | | x | | 65-90 |
| Muskmelons | | x | x | 75-90 |
| New Zealand spinach | | x | | 70-80 |
| Okra | | x | | 50-80 |
| Onions ³ | x | x | x | 40-120 |
| Parsley | x | x | | 70-90 |
| Parsnips | x | x | | 90-110 |

continued

Table 11. (continued)

| Vegetable | Frost-resistant | Seeds | Transplants | Days to Maturity ¹ |
|-----------------------------|-----------------|-------|-------------|-------------------------------|
| Peppers | | | x | 65-75 |
| Pumpkins | | x | | 90-120 |
| Southern peas | | x | | 60-70 |
| Summer squash | | x | | 50-55 |
| Sweet corn | | x | | 60-100 |
| Sweet potatoes ⁴ | | | x | 120-140 |
| Swiss chard | x | x | | 55-60 |
| Tomatoes | | | x | 60-90 |
| Watermelons | | x | x | 70-90 |
| Winter squash | | x | | 80-120 |

¹ Days given are for the early to late varieties.

² Irish potatoes are available as seed pieces.

³ Onions are also available in sets.

⁴ Sweet potatoes are available as rooted slips.

Note: Varieties which endure summer heat are available. Most of these crops can be seeded or transplanted during July and August and will develop quite well during midsummer's warm growing conditions, if you give them extra water and practice good insect pest control. As the crop develops, the cool, short days enable plants to accumulate sugar and flavor compounds providing the taste that makes many fall-grown crops so good.

Table 12. Crops for the fall garden.

| Vegetable | Date of Planting | Seeds | Transplants | Days to Maturity ¹ | Date of Harvest |
|-------------------|----------------------|-------|-------------|-------------------------------|-----------------|
| Beets | Jul - mid-Aug | x | | 70 - 75 | Oct |
| Bibb lettuce | Jul - Aug | x | x | 50 - 60 | Sep - Oct |
| Broccoli | Jul - Aug | | x | 60 - 80 | Sep - Nov |
| Brussels sprouts | Jun - Jul | | x | 70 - 80 | Oct - Nov |
| Cabbage | late Jun - early Aug | | x | 60 - 70 | Sep - Nov |
| Carrots | Jul - Aug | x | | 80 - 90 | Nov |
| Cauliflower | late Jun - early Aug | | x | 70 - 80 | Sep - Nov |
| Chinese cabbage | Jul - Aug | x | x | 50 - 70 | Sep - Nov |
| Collards | Jul - Aug | x | | 80 - 90 | Oct - Nov |
| Endive | Jul - Aug | x | x | 70 - 80 | Sep - Nov |
| Green beans, bush | Jul - mid-Aug | x | | 60 - 65 | Sep |
| Kale | Jul - Aug | x | x | 70 - 80 | Sep - Nov |
| Kohlrabi | Jul - Aug | x | | 60 - 70 | Sep - Nov |
| Leaf lettuce | Jul - Aug - Sep | x | x | 40 - 60 | Sep - Oct |
| Mustard greens | Jul - Aug | x | | 50 - 60 | Sep - Oct |
| Parsnips | June | x | | 90 - 100 | Nov |
| Potatoes | mid-Jun | x | | 90 - 100 | Oct |
| Radishes | Sep | x | | 30 - 40 | Oct |
| Rutabaga | July - mid-Aug | x | | 80 - 90 | Oct - Nov |
| Snow Peas | Aug | x | | 50 - 70 | Oct |
| Spinach | Aug - Sep | x | | 50 - 60 | Aug - Sep |
| Sweet corn | Jul | x | | 70 - 80 | Sep |
| Turnips | Jul - Aug | x | | 50 - 60 | Sep - Nov |
| Turnip greens | Jul - Aug | x | | 50 - 60 | Sep - Nov |

¹ Due to cool temperatures in the fall, a long time will be needed for certain crops to mature.

The Fall Garden

Gardening doesn't have to end with your summer-grown crops since some vegetables are suitable for late summer planting. Plan to follow your spring and summer gardens with a fall garden so that you can have fresh produce well into the winter.

Plant crops according to your planting plan, grouping plants to be sure short ones are not shaded by tall ones. To encourage good germination, fill each seed furrow with water and let it soak in. Keep the soil moist until seeds have germinated.

Fall vegetables are harvested after early September. They consist of two types:

1. the last succession plantings of warm-season crops, such as corn and bush beans,
2. cool-season crops which grow well during the cool fall days and withstand frost.

Note that cool nights slow growth, so crops take longer to mature in the fall (and spring) than in the summer. Keep this slower pace in mind when you check seed catalogs for the average days to maturity. Some of the best quality vegetables are produced during fall's warm days and cool nights. These environmental conditions add sugar to sweet corn and cole crops, and crispness to carrots.

The vegetables in Table 12 can be successfully seeded or transplanted for fall harvest. Often, you will want several seeding dates to extend the harvest over a longer time. This table gives the latest dates for either seeding or transplanting as indicated.

Table 13. Vegetable gardener's calendar for Western Kentucky.¹

| | | |
|----------|---|---|
| Jan. 15 | I | Onions |
| Feb. 1 | I | Brussels sprouts |
| Feb. 15 | I | Broccoli, cabbage, cauliflower, kohlrabi, lettuce, Chinese cabbage |
| Mar. 1 | O | Spinach, mustard, beets, peas, edible podded peas |
| Mar. 15 | M | Cabbage, kohlrabi |
| | O | Asparagus and rhubarb (crowns), beets, carrots, collards, kale, mustard, spinach, peas, edible podded peas, early potato seed pieces, radishes, turnips, green onions, onion sets, endive |
| | I | Peppers, tomatoes, eggplant, sweet potato slips. Dig and divide any 4-year-old rhubarb plants. Fertilize asparagus and rhubarb with 1 lb 5-10-10 per 100 sq ft. |
| Apr. 1 | M | Broccoli, cauliflower, collards, lettuce, Chinese cabbage, Swiss chard, onions from seeds |
| | O | Mustard, spinach, radishes, lettuce, Swiss chard |
| Apr. 5 | I | Muskmelons, watermelons, squash |
| | O | Sweet corn, beets, carrots, mustard, spinach, radishes, lettuce |
| May 1 | O | Sweet corn, mustard, radishes, lettuce |
| May 7 | O | Green beans, lima beans |
| | M | Tomatoes, muskmelons, watermelons, squash |
| June 1 | O | Sweet corn |
| | M | Sweet potatoes |
| June 15 | O | Sweet corn, late potatoes, summer squash, bush beans, lettuce, parsnips, beets, carrots |
| July 1 | O | Sweet corn (early maturing variety), carrots, beets |
| July 10 | O | Sow seeds of fall cole crops in a nursery area |
| July 15 | O | Sweet corn (early maturing variety), kale, mustard, turnips, summer squash |
| Aug. 1 | M | Transplant fall cole crops to permanent location between now and Aug. 15 |
| | O | Peas, edible podded peas, bush beans, radishes, beets, mustard. Divide old rhubarb or plant crowns if not done in spring. |
| Aug. 15 | O | Radishes, spinach, turnips, turnip greens, beets, mustard, lettuce, endive |
| Sept. 1 | O | Radishes, spinach, mustard |
| Sept. 15 | O | Radishes, mustard, turnips, turnip greens |
| Oct. 1 | O | Radishes |
| Oct. 15 | O | Sow sets of Egyptian tree or multiplier onions. Harvest carrots before heavy freeze. |
| Nov. 1 | O | Dig parsnips and store at 32-40°F, or mulch parsnips heavily in the ground |

I: Start seeds indoors; **M:** Move transplants to garden; **O:** Start seeds outdoors

¹ Add ten days for central Kentucky and 15 days for the eastern mountains of Kentucky to these dates for spring and summer crops. Subtract ten or 15 days for fall crops

Extending the Growing Season

Polyethylene row covers have been used for a long time to help vegetables grow and ripen early in the spring. However, Kentucky's springs are often too warm to benefit much from early season row covers. During the fall, on the other hand, these covers might prove useful to gardeners wishing to extend the harvest of frost-sensitive crops (tomatoes, peppers, cucumbers). The objective of using a row cover is to trap heat from the soil and protect the crop from cold night temperatures which might deform fruit or kill the plant. Many times in Kentucky, a period of mild weather will follow the first killing frost. If you protect frost-sensitive vegetables at critical times in the fall you could extend the harvest season by several weeks. However, the tall stature of some of these crops (tomatoes) makes it more difficult to protect them using row covers. A second use of season extension might be to grow certain frost tolerant vegetables during the winter months.

Figure 8. Slitted row cover.

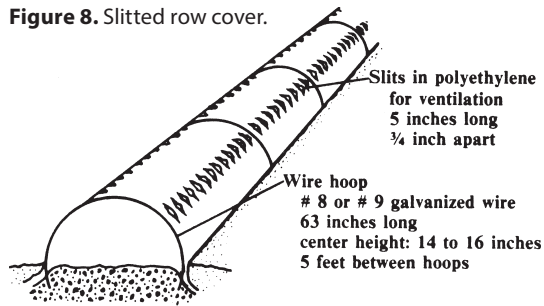

Vegetables like carrots, turnips, leeks, cabbage, lettuce, spinach, kale, and other leafy greens, are generally planted in the spring garden where they tolerate frost and freezing conditions. These vegetable are fairly low growing which would allow them to mature under row covers and their proximity to the ground helps protect them during extremely cold weather. Using solid plastic covering (low tunnels, see below), these greens may grow well into winter or even all winter long when temperature are not extreme (subzero F). But the nature of the low tunnel will require the growing beds to be ventilated during sunny conditions.

Gardeners have a choice of self-ventilating covers (slitted or perforated), low tunnel covers, or floating row covers. The slitted and perforated types as well as the plastic used for low tunnels are available in clear and opaque polyethylene and require wire hoops or PVC pipe for support. To construct such tunnels after planting, push hoops (made from no. 9 galvanized wire or PVC pipe) into the ground, and spaced 5 feet apart over the row (Figure 8). Then when frost or freeze is predicted, cover them with clear polyethylene. Bury the edges of the plastic in the ground. For floating row covers, simply place the fabric directly over the crop and secure at the edges. The slitted sides of perforated covers and the loose nature of floating row covers allow needed ventilation on sunny days to prevent overheating. However these season extension devices provide less protection from cold at night. Low tunnels made with solid plastic offers the best protection at night but must be ventilated by loosening the sides or ends during sunny days. Without ventilation, temperatures under the cover may quickly reach crop-damaging levels on sunny days. Raised bed gardens are generally easily adapted to low tunnel culture.

Figure 9. Average date of last killing frost (36°F) in spring, plus average number of days between last frost in spring and first frost in fall.

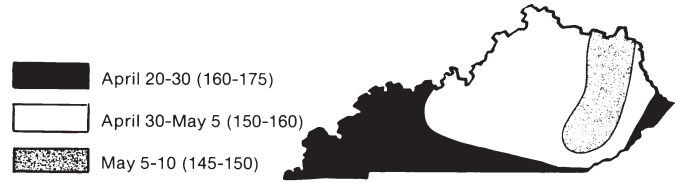

Table 14. Earliest and latest planting dates in the garden in Kentucky. (If producing your own transplants, begin two to 12 weeks earlier than these listed dates. See Table 5.)

| Crops | Earliest Safe Planting Date | | | Latest Safe Planting Date ¹ | | |
|-----------------------|-----------------------------|---------|---------|--|---------|---------|
| | Western | Central | Eastern | Eastern | Central | Western |
| Asparagus (crowns) | Mar 10 | Mar 15 | Mar 20 | (Spring only) | | |
| Beans (snap) | Apr 10 | Apr 25 | May 1 | July 15 | July 25 | Aug 1 |
| Beans (lima) | Apr 15 | May 1 | May 10 | June 15 | June 20 | July 1 |
| Beets | Mar 10 | Mar 15 | Mar 20 | Aug 1 | Aug 10 | Aug 15 |
| Broccoli (plants) | Mar 30 | Apr 5 | Apr 10 | July 15 | Aug 1 | Aug 15 |
| B. Sprouts (plants) | Mar 30 | Apr 5 | Apr 10 | July 1 | July 15 | Aug 1 |
| Cabbage | Mar 15 | Mar 25 | Apr 1 | July 1 | July 15 | Aug 1 |
| Carrots | Mar 10 | Mar 20 | Apr 1 | July 1 | July 15 | Aug 1 |
| Cauliflower (plants) | Mar 30 | Apr 5 | Apr 10 | July 15 | July 20 | Aug 5 |
| Celery | Apr 1 | Apr 5 | Apr 10 | June 15 | July 1 | July 15 |
| Chard | Mar 15 | Mar 20 | Apr 1 | June 15 | July 15 | Aug 1 |
| Collards | Mar 1 | Mar 10 | Mar 15 | Aug 15 | Aug 20 | Aug 30 |
| Sweet Corn | Apr 10 | Apr 20 | May 1 | June 15 | July 10 | July 20 |
| Cucumbers | Apr 20 | May 1 | May 10 | June 15 | July 1 | July 15 |
| Eggplant (plants) | May 1 | May 10 | May 15 | June 1 | June 15 | July 1 |
| Kale | Mar 10 | Mar 20 | Apr 1 | July 15 | Aug 1 | Aug 15 |
| Kohlrabi | Mar 15 | Mar 20 | Mar 25 | July 15 | Aug 1 | Aug 15 |
| Lettuce (leaf) | Mar 15 | Mar 25 | Apr 1 | Aug 1 | Aug 15 | Sept 1 |
| Lettuce (bibb plants) | Mar 15 | Mar 25 | Apr 1 | July 15 | Aug 1 | Aug 15 |
| Lettuce (head plants) | Mar 15 | Mar 25 | Apr 1 | July 1 | July 15 | Aug 1 |
| Muskmelons | Apr 20 | May 10 | May 15 | June 15 | July 1 | July 15 |
| Okra | Apr 20 | May 10 | May 15 | July 1 | July 15 | Aug 1 |
| Onions (sets) | Mar 1 | Mar 10 | Mar 15 | (Spring only) | | |
| Onions (plants) | Mar 15 | Mar 25 | Apr 1 | June 15 | July 1 | July 15 |
| Onions (seed) | Mar 10 | Mar 20 | Apr 1 | June 1 | June 15 | July 1 |
| Parsley | Mar 10 | Mar 20 | Apr 1 | July 15 | Aug 1 | Aug 15 |
| Parsnips | Mar 10 | Mar 20 | Apr 1 | June 1 | June 15 | July 1 |
| Peas | Feb 20 | Mar 1 | Mar 15 | (Spring only) | | |
| Peppers (plants) | May 1 | May 10 | May 20 | June 15 | July 1 | July 15 |
| Irish Potatoes | Mar 15 | Mar 15 | Mar 20 | June 15 | July 1 | July 15 |
| Sweet Potatoes | May 1 | May 10 | May 20 | June 1 | June 10 | June 15 |
| Pumpkins | Apr 20 | May 5 | May 10 | June 1 | June 15 | July 1 |
| Radishes | Mar 1 | Mar 10 | Mar 15 | Sept 1 | Sept 15 | Oct 1 |
| Rhubarb (crowns) | Mar 1 | Mar 10 | Mar 15 | (Spring only) | | |
| Rutabaga | Mar 1 | Mar 10 | Mar 15 | July 1 | July 10 | July 15 |
| Southern Peas | Apr 20 | May 5 | May 10 | June 15 | July 1 | July 15 |
| Snow Peas | Feb 20 | Mar 1 | Mar 15 | July 20 | Aug 1 | Aug 8 |
| Spinach | Feb 15 | Mar 1 | Mar 10 | Aug 15 | Sept 1 | Sept 15 |
| Summer Squash | Apr 20 | May 10 | May 15 | July 15 | Aug 1 | Aug 15 |
| Tomatoes (plants) | Apr 20 | May 5 | May 15 | June 1 | June 15 | July 1 |
| Turnips | Mar 1 | Mar 10 | Mar 15 | Aug 1 | Aug 10 | Aug 20 |
| Watermelons | Apr 20 | May 5 | May 15 | June 15 | July 1 | July 15 |
| Winter Squash | Apr 20 | May 10 | May 15 | June 15 | July 1 | July 15 |

¹ Based on average of early maturing varieties. Mid-season and late-maturing varieties need to be planted 15 to 30 days earlier than latest date. Nearly all of the fall-planted garden crops will require irrigation during dry periods. Additional insect controls may be necessary for these tender young plants.

Table 15. Vegetable yields and amounts to plant per person.

| Vegetable | Avg. Crop Expected per 100 Feet | Approx. Planting/Person | |
|-------------------|---------------------------------|-------------------------|------------------------------|
| | | Fresh | Storage, Canning or Freezing |
| Asparagus | 30 lb | 10-15 plants | 10-15 plants |
| Beans, snap bush | 120 lb | 15-16 ft | 15-20 ft |
| Beans, snap pole | 150 lb | 5-6 ft | 8-10 ft |
| Beans, lima bush | 25 lb shelled | 10-15 ft | 15-20 ft |
| Beans, lima pole | 50 lb shelled | 5-6 ft | 8-10 ft |
| Beets | 150 lb | 5-10 ft | 10-20 ft |
| Broccoli | 100 lb | 3-5 plants | 5-6 plants |
| Brussels sprouts | 75 lb | 2-5 plants | 5-8 plants |
| Cabbage | 150 lb | 3-4 plants | 5-10 plants |
| Cabbage, Chinese | 80 heads | 3-10 ft | --- |
| Carrots | 100 lb | 5-10 ft | 10-15 ft |
| Cauliflower | 100 lb | 3-5 plants | 8-12 plants |
| Celeriac | 60 lb | 5 ft | 5 ft |
| Celery | 180 stalks | 10 stalks | --- |
| Chard, Swiss | 75 lb | 3-5 plants | 8-12 plants |
| Collards and Kale | 100 lb | 5-10 ft | 5-10 ft |
| Corn, sweet | 10 dozen | 10-15 ft | 30-50 ft |
| Cucumbers | 120 lb | 1-2 hills | 3-5 hills |
| Eggplant | 100 lb | 2-3 plants | 2-3 plants |
| Garlic | 40 lb | --- | 1-5 ft |
| Kohlrabi | 75 lb | 3-5 ft | 5-10 ft |
| Lettuce, head | 100 heads | 10 ft | --- |
| Lettuce, leaf | 50 lb | 10 ft | --- |

continued

Table 15. (continued)

| Vegetable | Avg. Crop Expected per 100 Feet | Approx. Planting/Person | |
|-------------------------|---------------------------------|-------------------------|------------------------------|
| | | Fresh | Storage, Canning or Freezing |
| Muskmelons (cantaloupe) | 100 fruits | 3-5 hills | --- |
| Mustard | 100 lb | 5-10 ft | 10-15 ft |
| Okra | 100 lb | 4-6 ft | 6-10 ft |
| Onions (plants or sets) | 100 lb | 3-5 ft | 30-50 ft |
| Onions (seed) | 100 lb | 3-5 ft | 30-50 ft |
| Parsley | 30 lb | 1-3 ft | 1-3 ft |
| Parsnips | 100 lb | 10 ft | 10 ft |
| Peas, English | 20 lb | 15-20 ft | 40-60 ft |
| Peas, Snow | 20 lb | 10-15 ft | 30-40 ft |
| Peas, Southern | 40 lb | 10-15 ft | 20-50 ft |
| Peppers | 60 lb | 3-5 plants | 3-5 plants |
| Potatoes, Irish | 100 lb | 50-100 ft | --- |
| Potatoes, Sweet | 100 lb | 5-10 plants | 10-20 plants |
| Pumpkins | 100 lb | 1-2 hills | 1-2 hills |
| Radishes | 100 bunches | 3-5 ft | --- |
| Salsify | 100 lb | 5 ft | 5 ft |
| Soybeans | 20 lb | 50 ft | 50 ft |
| Spinach | 40-50 lb | 5-10 ft | 10-15 ft |
| Squash, summer | 150 lb | 2-3 hills | 2-3 hills |
| Squash, winter | 100 lb | 1-3 hills | 1-3 hills |
| Tomatoes | 100 lb | 3-5 plants | 5-10 plants |
| Turnip greens | 50-100 lb | 5-10 ft | --- |
| Turnip roots | 50-100 lb | 5-10 ft | 5-10 ft |
| Watermelons | 40 fruits | 2-4 hills | --- |

Caring for Your Vegetables During the Growing Season

Once planting is completed, your garden still requires careful attention. You need to see that your plants receive the proper amounts of water and nutrients all season long.

Irrigating

Vegetable crops need about 1 inch of water per week, as rain water, irrigation water or both, from April through September. You should have a rain gauge near your garden or check with the local weather bureau for rainfall amounts; then supplement rainfall with irrigation if needed. An average garden soil will store about 1.5 inches of water/foot of depth.

Irrigation aids seedling emergence, improves percent germination and plant stand, helps maintain uniform growth and permits fruit development. Soils often crust without adequate water, retarding the germination of crops like carrots, onions and beans.

Another use of irrigation is to reduce the wilting of transplanted crops like tomato, pepper, lettuce, cabbage and eggplant. A good supply of soil moisture improves the quality and yields of all crops, increases the fruit size of tomatoes, cucumbers and melons, and prevents premature ripening in crops such as peas, sweet corn and beans. The critical periods of water needs for various vegetables are shown in Table 16.

If overhead irrigation is used, it is a good idea to irrigate during the day so that all the water is evaporated off the plant foliage before dark. This reduces disease problems.

Table 16. Critical times to water vegetables.

| Vegetable | Critical Period of Water Need |
|----------------|--|
| Asparagus | Fern growth |
| Bean, lima | Pollination and pod development |
| Bean, snap | Bloom, pollination and pod enlargement |
| Broccoli | Establishment, crown development |
| Cabbage | Establishment, head development |
| Carrot | Establishment, root enlargement |
| Cauliflower | Establishment, growth, head development |
| Corn, sweet | Silking, tasseling and ear development |
| Cucumber | Flowering and fruit development |
| Eggplant | Uniform supply from flowering through harvest |
| Melon | Fruit set and early development |
| Onion, dry | Bulb enlargement |
| Pea | Flowering and seed enlargement |
| Pepper | Uniform supply from flowering through harvest |
| Potato | Tuber set and tuber enlargement |
| Radish | Root enlargement |
| Squash, summer | Bud development, flowering and fruit development |
| Tomato | Uniform supply from flowering through harvest |
| Turnip | Root enlargement |

Water Movement in Soil

When water is applied to the soil, it seeps down through the root zone gradually. Each layer of soil must be saturated before water will descend to the next layer. This water movement is referred to as the wetting front. If only one-half the amount of water is applied at a given time, it will penetrate the top half of the root

zone; the area below the point where the wetting front stops will remain as dry as if no irrigation had been applied at all.

The total water a garden needs is the same as the amount of water lost from the plant plus the amount evaporated from the soil. These two processes are called evapotranspiration. Evapotranspiration rates vary and are influenced by day length, temperature, cloud cover, wind, relative humidity, mulching, and type, size and number of plants growing in a given area.

Watering areas of the garden not occupied by vegetable roots only encourages weed growth.

Watering Equipment

The home gardener has several choices of watering equipment, including the garden hose with a spray or fan nozzle, trickle systems and porous hose systems. This equipment may or may not be semiautomatic. Many portable lawn sprinklers are adequate for the garden. Adjust the rate of water application to about 1/2 inch/hour. A faster rate may cause runoff.

Oscillating and rotating sprinklers must be placed on a platform higher than the crop being irrigated to keep the plants from distorting the spray pattern and getting uneven distribution. Rotating sprinklers deliver circular water patterns with more water near the center than on the outer edges. Oscillating sprinklers deliver rectangular patterns, making it easy to water along edges of gardens; these systems, however, deliver more water at the edges than in the center. In any case, sprinklers do not distribute water uniformly like rain, though you can even out the water by overlapping the patterns. However, such overlapping means you must move the sprinkler often, overlapping about half of the area already watered each time you move it.

To check how much water your sprinkler has applied, set several small, straight-sided cans on the ground at varying distances from the operating sprinkler. If the sprinkler is set to apply 1 inch of water, operate it until the can with the most water has about 1/2 inch in it. Then, shut off or move the sprinkler to another spot. Overlap the measured can and run the sprinkler again until the can has a total of 1 inch of water in it.

An excellent irrigation system for the home garden is the perforated plastic hose or soaker hose. Put the hose, holes down, along one side of the crop row or underneath plastic mulch. Let the water soak or seep slowly into the soil. This method requires less water because the water goes right next to the plant. Also, this way you can water in the evening without encouraging foliage diseases since no water is sprinkled on the plant leaves. You can determine the time required to apply a given volume of water by putting one of the hole openings over a can and measuring the amount of water collected in a given time period.

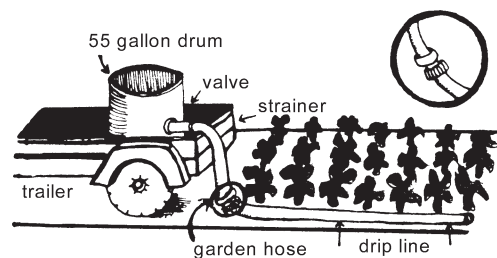

Figure 11. Trickle system for a garden that is too far from a water supply.

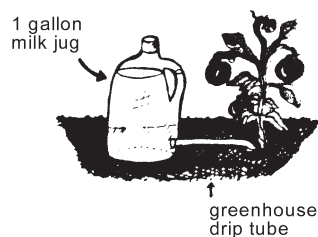

Figure 12. Trickle system for favorite plants (i.e., giant pumpkin, early tomatoes, etc.).

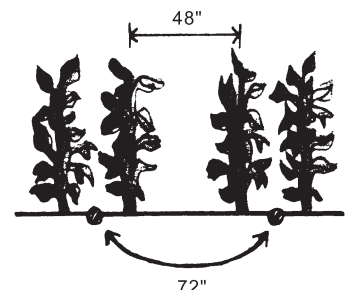

Figure 13. One trickle line for every two rows.

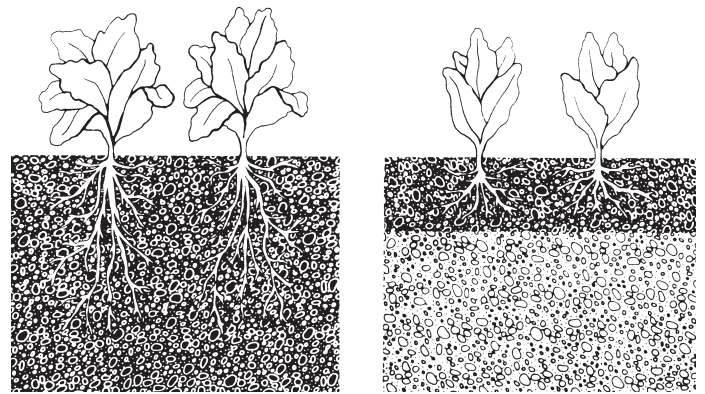

Figure 10. To encourage deep rooting, thoroughly water the upper 6 - 8 inches of soil (left). Shallow watering (right) promotes shallow development of roots, resulting in poor growth and increased risk of injury under severe weather conditions.

With trickle irrigation you water vegetables similarly to the way you sidedress fertilizer. Water is applied directly on the row by a special hose or tube at low pressure. Trickle irrigation uses from 30% to 70% of the water required by overhead sprinkle irrigation.

You do not need to be a plumber to construct a trickle irrigation system. For the first year, you may wish to install trickle irrigation on only a few rows of vegetables.

Trickle irrigation equipment is usually available from local garden supply stores and is also listed in many seed and garden catalogs available to home gardeners.

Line Emitters (for Trickle Irrigation)

Three principal types of line emitters are adapted to growing vegetables (see Figure 14).

1. Twin-wall is essentially a tube within a tube. Water from the feeder line fills the inside tube. When pressure on the inside tube builds up, the water flows through holes spaced about 5 feet apart into the outer tube. Water then trickles through perforations spaced about 12 inches apart in the outer tube and into the soil.
2. Bi-wall has a main chamber through which water flows until pressure is the same throughout the trickle line. Water then flows into a secondary chamber on top of the main chamber and is distributed to the plants through holes along the entire secondary chamber.
3. With a plastic soaker hose water seeps through the tube's entire length, not at defined openings. The soaker hose is ideal for closely spaced crops.

Although not used for vegetables, point emitters are available to deliver water to specific locations. They are used to water shrubs and trees.

Trickle Irrigation and Black Plastic Mulch

Black plastic mulch can be put over the line emitter to increase the effectiveness of watering and to control weeds. Further, the black plastic protects the polyethylene emitter tube from sunlight which accelerates material break down. The tubes can be used for several years if cleaned and stored in a cool, dark place. Black plastic mulch, 0.0015 inches (1 ½ mil) thick, may be purchased at garden supply stores. A 4-foot width is ideal for most vegetables.

If you use a trickle system with plastic mulch, you must put the line emitter 8 inches to one side of the center of the row. This precaution assures that the plastic emitter hose will not be punctured when plants are set in the middle of the row. Figure 15 shows a line emitter installed under black plastic mulch.

Fertilizer—Although a crop could be fertilized if you inject soluble fertilizers into the supply pipe in a home trickle watering system, this method involves a greater risk of applying the wrong amount of fertilizer. Since the black plastic sheet reduces the loss of fertilizer by eliminating downward movement during heavy rain, you can reduce the amount of fertilizer by about 25%.

After lime and fertilizers are applied and raked into the top few inches of soil, the trickle system is installed and the plastic mulch is placed on top. Directions for installing plastic mulch are in the section on mulching.

Mulching

Mulching can make all the difference between a garden that is a joy to work and watch and one that is tedious and untidy.

Among mulch's greatest attributes is its ability to help control weeds.

Mulch also helps conserve soil moisture by 50% or more by covering the soil to slow down evaporation. UK soil scientists have found that a mulch on the soil surface can conserve about 6 inches of soil water during the growing season. Most of the water conserved will reduce and/or delay plant water stress.

Mulch reduces erosion by breaking the impact of rain and wind.

Nutrients do not leach so readily under plastic and some paper mulches because less rainwater penetrates.

Vegetables remain cleaner in mulched gardens because they have less contact with the soil.

Finally, organic mulches can keep soils cool.

Using Plastic Mulch

The most common materials for mulching are either plastic or organic matter. Plastic materials are usually 3 or 4 feet wide and are black, white, brown or clear. The darker plastics are recommended because they do not allow weed growth; clear materials act as greenhouses under which weeds flourish. White-on-black plastic is used for summer planting, because it is cooler.

Plastic mulches tend to warm the soil by about 1 to 5 degrees. This extra warmth can boost plants such as tomatoes in the spring and can promote quite vigorous growth of heat-loving vine crops, such as melons and squashes, in the summer.

- Wait for a calm day to lay plastic mulches.
- Slip a hoe or rake handle through the roll of polyethylene.
- Place the roll at the beginning of the row.
- Hoe furrows about 4 inches deep on either side of the roll.
- Roll out the polyethylene this distance.
- Tuck the edges into the furrows.
- Cover them with soil and proceed another 5 ft until the end of the row.
- Slit the plastic at the end of the row and place the edge into a furrow across the row.
- Insert transplants by cutting holes in the plastic with a knife or bulb planter.
- Plastic weed barrier or landscape fabric mulches, which are more expensive than other plastic mulches, allow water to pass through, can be held down with large wire staples, and can be reused in subsequent years.

Some soil between the rows will remain unmulched. Or, you may wish to use newspapers and organic mulch to control weeds between the plastic strips.

The major disadvantage of most plastic mulches is that you have to remove them and dispose of them. They cannot be tilled under or left on the soil, but must be lifted and discarded. New biodegradable mulches are now available at some garden stores.

Using Organic Mulches

Organic mulches are materials such as lawn clippings or straw. Do not use lawn clippings that come from a lawn recently treated with herbicides. The finer mulches will deter weeds if spread over the garden at least 2 inches deep. One excellent way to spread these materials more thinly is to first lay about six sheets of newspaper on the soil, then cover the paper with organic matter. In this case the newspaper is really the mulch, and the organic matter holds the paper in place and improves appearances.

Soils will remain cool longer in the spring under organic mulches, because the sun does not strike the soil. If you want your garden to grow rapidly in the spring, do not scatter the mulch until the soil warms. One precaution needed if you use straw is to be sure it is weed- and seed-free. Otherwise, it will be a source of weeds for the growing season.

Figure 14. Trickle tubes.

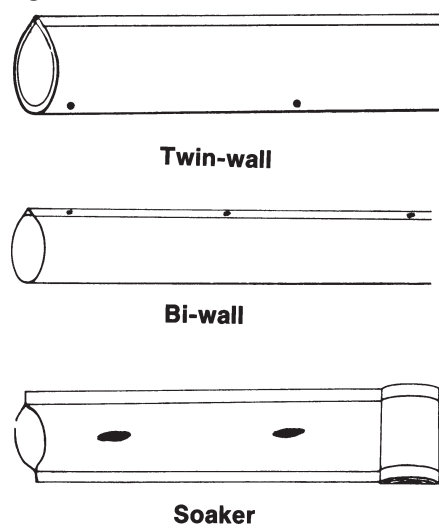
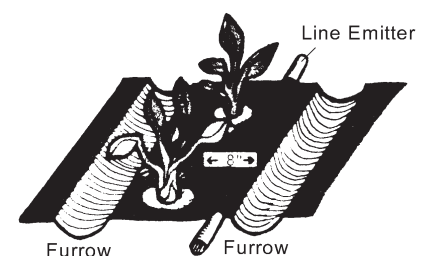
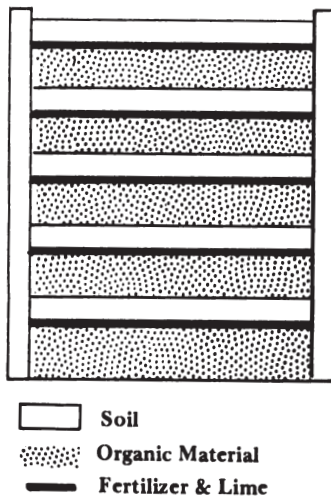

Figure 15. Installation of trickle irrigation under black plastic mulch.



Punch hole 3 to 4 inches in diameter into the installed plastic mulch. Fill furrows with soil.

Figure 16. Layers for a compost pile.



Most organic mulches will compact and start to decompose by fall. They can be tilled under easily, adding valuable organic matter to the soil. Some gardeners prefer to maintain a permanent mulch, adding organic material as it becomes available. In the spring, they simply pull back the mulch in spots for transplants or in rows for direct-seeded vegetables. This method is a good way to build a rich garden soil.

Fertilizing

For vegetables to produce lush, continuous growth throughout the season, they need a uniform supply of nutrients. However, many chemical fertilizers are very soluble, so the initial application may leach beyond the root zone before the growing season ends. Thus, many gardeners sidedress their crops with an extra application of fertilizer during the growing season. The usual rate is 5 Tbs of high nitrogen analysis fertilizer such as 33-0-0 or 2.5 oz. of 10-10-10/10 feet of row.

A combination of chemical fertilizer, organic fertilizer and mulch makes a good sidedressing. The chemical fertilizers give the initial boost required by young plants; organic fertilizers provide nutrients uniformly throughout the season; and mulch keeps the soil more evenly moist and the nutrients more uniformly available.

Compost

Compost is easy to make; all you need is raw organic matter, soil and fertilizer. Leaves, grass clippings, weeds, garden refuse and manure are excellent organic materials to use. Special additives don't help, though nitrogen fertilizer may speed up composting. A shredder will make the organic materials finer, further speeding up decomposition.

Compost can be started anytime. Choose an area convenient to the garden and backdoor so that garden residue and kitchen parings can be easily added. The best location is a shady spot; however, do not build directly under a tree, because the tree's roots may grow into the pile. Make two or three open-ended bins or boxes to

Table 17. Recommended times for sidedressing vegetables. (General rate for sidedressing is 5 Tbs of a high nitrogen analysis fertilizer such as 33-0-0/10 ft row for all vegetables except asparagus and onions, which require 10 Tbs/10 ft row, and potatoes, which require 7 Tbs/10 ft row.)

| Crop | Time of Application |
|----------------|---|
| Asparagus | Before growth starts in spring and again after harvest. Phosphorus and potassium may also be applied at these times if needed. See Asparagus section. |
| Beans | After heavy blossom and set of pods. |
| Beets | Additional nitrogen might reduce yield or lower quality. |
| Broccoli | 3 weeks after transplanting. |
| Cabbage | 3 weeks after transplanting. |
| Cauliflower | 3 weeks after transplanting. |
| Carrots | Additional nitrogen might reduce yield or lower quality. |
| Cucumbers | Apply 1 week after blossoming begins and same amount 3 weeks later. |
| Eggplant | After first fruit set. |
| Kale | When plants are about one-third grown. |
| Lettuce | Additional nitrogen might reduce yield or lower quality. |
| Muskmelons | Apply 1 week after blossoming begins and same amount 3 weeks later. |
| Onions | 1 to 2 weeks after bulb formation starts. |
| Parsnips | Additional nitrogen might reduce yield or lower quality. |
| Peas | After heavy bloom and set of pods. |
| Peppers | After first fruit set. |
| Potatoes | After tuber formation starts (bloom stage), about 6 weeks after planting. |
| Spinach | When plants are about one-third grown. |
| Squash | Additional nitrogen might reduce yield or lower quality. |
| Sweet corn | When plants are 12 inches tall. |
| Sweet potatoes | Additional nitrogen might reduce yield or lower quality. |
| Tomatoes | Apply 1 to 2 weeks before first picking and same amount 2 weeks after first picking. |
| Turnips | Additional nitrogen might reduce yield or lower quality. |
| Watermelon | Additional nitrogen might reduce yield or lower quality. |

hold the compost. They can be 3 to 5 feet wide, 3 to 4 feet high and any length. You can build the boxes of wire fencing supported by posts, or they may be constructed of boards or masonry material. They can be made attractive enough to be part of the landscape.

To make a compost pile, alternate layers of raw organic material, fertilizer and soil (see Figure 16). Start with organic matter—6 inches deep if the material is fairly solid, or 12 inches deep if it is loose. Add water if the material is dry. Next, add either an organic or synthetic fertilizer that is high in nitrogen. For general use compost, add 34-0-0 analysis fertilizer at the rate of ½ cup per bushel of compact organic matter.

After you fertilize, add a 1-inch layer of soil. The soil introduces microorganisms which decompose organic matter. Commercial microbial preparations which claim to enhance composting are unnecessary. Continue to alternate layers of organic matter, fertilizer and soil until the pile is 3 to 4 feet high, but slightly lower in the center for easy watering. Complete the pile with a layer of soil on the top.

Keep your compost moist but not soggy. With moisture, and a layer of soil on the top, no offensive odors should exist.

Turn or mix your compost pile several times during the year. For doing so, a second bin and a shredder come in handy. After mixing your pile into the second bin, you can start a new compost pile in the first one. If you start your compost in the fall and turn it several times, it should be ready for use about June 1.

Note—Fresh animal manures sometimes contain organisms that can make people sick (pathogens), such as the bacteria *Salmonella* sp. and *E. coli* O157:H7, or the parasite *Cryptosporidium parvum*. These pathogens can be present in soil that adheres to roots or low-growing leaves and fruits. The risk is minimized if no fresh manure is used in the garden.

Careful peeling or washing fruits and vegetables with detergent removes most pathogens, but some risk remains. Thorough cooking effectively kills pathogens.

The greatest risk from manure-borne pathogens is for low-growing or underground crops such as carrots, lettuce, and strawberries. The edible part of these crops may become contaminated with soil, the crops are difficult to wash, and they often are eaten raw.

Pathogens in fresh manure typically die over time, especially when the manure dries out or is exposed to freezing and thawing. The rate of die-off depends on the type of pathogen and manure and on environmental conditions such as temperature, moisture, and sunlight. Thorough, high-temperature composting kills pathogens, but it is difficult to maintain these conditions in a backyard compost pile. If any manure is used in the garden (even in compost) the gardener should wait at least 120 days between application to the garden and harvest. You can limit your risk by excluding fresh manure from compost that will be used on fresh garden crops.

Keep dog, cat, and pig manure out of your compost pile and garden. Some of the parasites found in these manures may survive a long time in compost or in the soil and remain infectious for people.

Cover Crops Protect Garden Plots

The garden plot—that area of tilled ground which offers an abundance of high-quality vegetables—is commonly used for only six to seven months in Kentucky.

What normally happens to the garden in the off-season can be wasteful and destructive. Wind and water may carry away the enriched topsoil. Rains will move minerals down through the soil, leaching them away from the root zone of vegetables. Compaction of soil occurs because of raindrops' impact or footsteps on the bare ground, as well as from loss of granular structure due to tillage and crop production practices. Weeds become established, leaving their seeds or perennial roots to plague the garden in future growing seasons. Some insects and diseases of vegetables overwinter on weeds and are right there on site to infect the next crop.

These problems can be reduced or eliminated with a cover crop to maintain and rejuvenate the garden soil. The benefits of cover crops are reaped in future vegetable harvests. Traditional cover crops are ryegrass, winter rye, winter wheat, oats, white clover, sweet clover, Austrian winter/field peas, hairy vetch, other legumes and buckwheat.

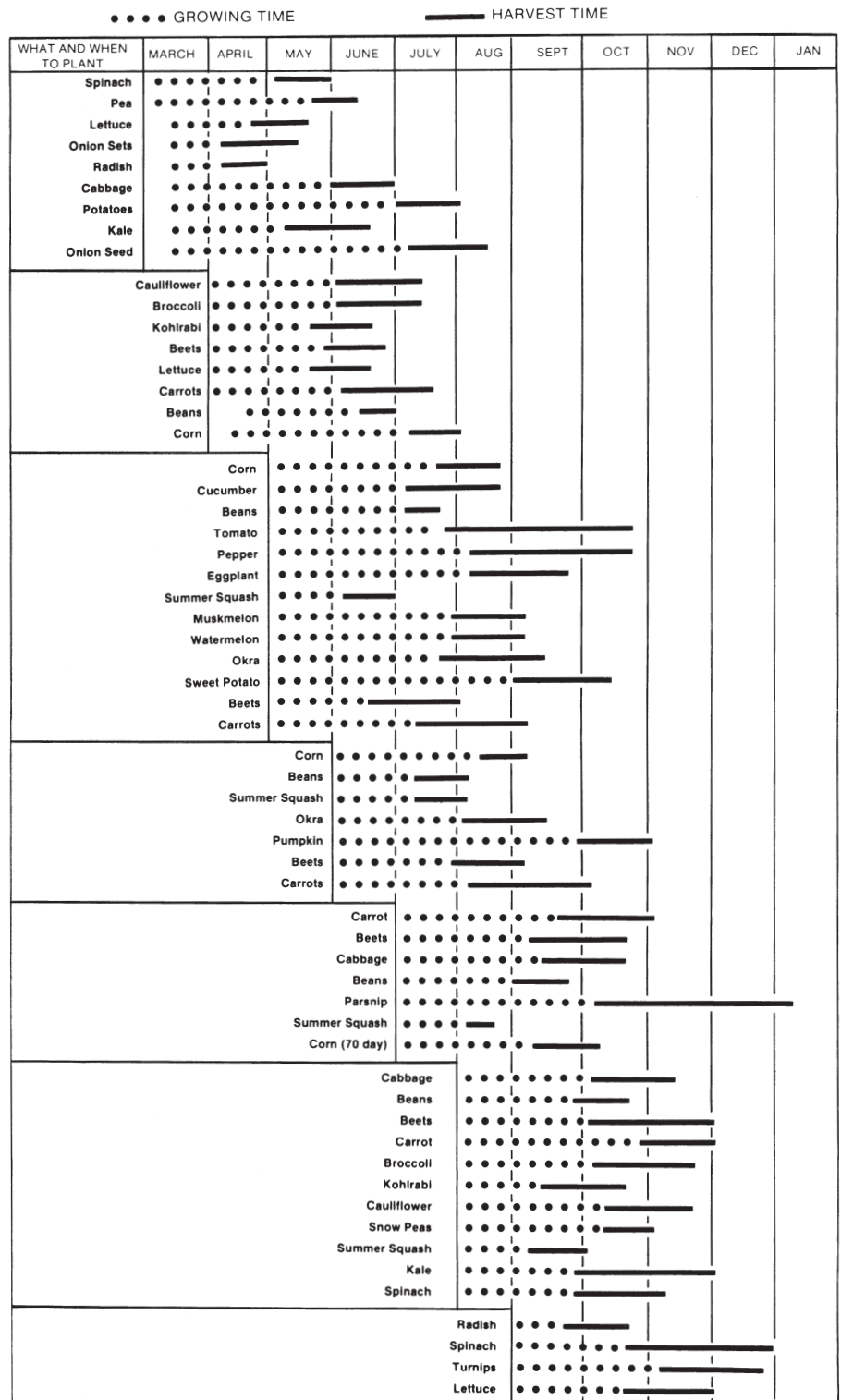

Figure 17. Vegetable crop timetable.

Cover crops can do even more than retain the soil, prevent mineral leaching, reduce compaction and competitively shade out weeds. A lush top growth, termed "green manure," will add organic matter when tilled into the garden soil. But the cover crop's root system is much more valuable than top growth to the soil quality, offering both organic matter and structural granulation as its roots grow through the soil. The roots improve garden soil's aeration and drainage while the tops intercept light energy at times when the garden would not be planted.

Success in growing cover crops requires proper crop selection, correct timing and good management techniques.

Grasses are much easier to establish than legumes, however including a legume in your cover crop mix has many benefits. Legume cover crops have a symbiotic relationship with certain soil microorganisms that allow for nitrogen to be fixed directly from the atmosphere. Nitrogen accumulations by leguminous cover crops range from 40 to 200 lbs. of nitrogen per acre which becomes gradually available throughout the growing season after the cover crop is incorporated. Oats mixed with Austrian winter/field peas and winter rye mixed with hairy vetch have both proven to be excellent cover crop mixes in Kentucky.

Small-seeded crops are slow and more difficult than large-seeded types such as oats. Winter rye and ryegrass grow very densely and are much more effective at shading out weeds than oats or small-seeded legumes. Availability of seed and its cost are other important considerations.

When you plant the cover crop will dictate which crops you can use. By October, only rye and winter wheat can be successfully started. If land is available in August, your choice broadens to include ryegrass, oats and clover. Covers such as annual rye-

grass, oats and buckwheat that do not overwinter are easiest to work with the next spring.

Perennial ryegrass and winter rye can give you problems in the spring. They produce a massive amount of top growth and will tangle in a rototiller. Before leaves grow too large, cut them back once with a mower, string trimmer or scythe. Perennial ryegrass makes a tight mass of fibrous roots which can be hard to manage.

Whatever cover crop you use, when the time comes to plant your garden you must remove the cover. You can completely avoid tilling by mowing the plot, broadcasting fertilizer and covering it with black plastic. The absence of light will kill the cover crop within two weeks, and transplants or large-seeded vegetable crops can be planted directly through the plastic. This no-till technique maintains excellent soil conditions, controls weeds and usually gives high yields.

For Kentucky's conditions, consider ryegrass as the best garden cover crop. It is a vigorous grower with an extensive root system occupying the same root zone as the vegetables will. Winter rye is an excellent second choice and best for late planting. It is a biennial, and mowing will stop its growth in spring.

Diseases, Insects and Weeds

Disease Control

Plants in the garden can be attacked and damaged by fungi, bacteria, nematodes and viruses. The symptoms of these attacks are called plant diseases. Plant diseases can be prevented or controlled in a variety of ways. Both urban and rural home gardeners can often use nonchemical methods effectively because they are willing to bear time and labor costs. When chemicals must be used, home gardeners can get by with few chemical applications by spraying only when needed.

Before Planting

- Select a site that is sunny and well-drained.
- Remove or deep-plow under old crop debris well before planting.
- Select disease-resistant varieties.
- Purchase disease-free transplants.
- Practice crop rotation (yes, it can be done in small gardens, but it requires that records be kept).
- Avoid areas with poor air movement.

At Planting Time

- Consider seed commercially treated with fungicides.
- Plant seed into warm soils.
- Space plants to assure air movement between plants.
- Use proper fertility.
- Use raised beds to improve drainage.
- Avoid overlapping plantings to keep diseases from moving from the old crop to the new one.

During the Growing Season

- Regularly inspect plants for disease.

- Remove and destroy diseased plants—do not place them in your compost pile.
- Control weeds, which harbor insects and disease organisms in and near the garden. These weeds include pokeweed, plantain, Johnsongrass, milkweed, wild cucumber, nightshade, ground cherry and clovers.
- Control insects which feed on vegetable plants or vector disease organisms.
- Water and mulch to avoid unnecessary plant stress. Avoid wetting foliage, or irrigate early in the day so foliage can dry before dark.
- Use labeled fungicides only when needed.
- Avoid working in the vegetable garden when leaves are wet to reduce spread of bacterial blights.
- Space plants appropriately to encourage air movement.

Fungicides

The number of chemicals labeled for use in home vegetable gardens is limited compared to the number available to producers of commercial vegetables. Gardeners should rely on preventive practices rather than pesticides to manage diseases. Use fungicides to supplement cultural controls—this will greatly reduce the need for chemicals in the garden.

Seed treatment with fungicides must be applied by commercial seed treaters. Grower application of these products is prohibited to minimize applicator exposure. If you desire to use treated seed, buy seed pre-treated with fungicides.

Fungicides available to home gardeners are *protectants* by nature and will not cure existing infections or symptoms. Protectant fungicides should be applied in a preventive manner to plant parts ideally before pathogens arrive (or no later than development of first symptoms). This is very different from the approach taken

with most insecticides. Don't wait until severe damage has occurred before deciding to use a fungicide. The majority of plant diseases tend to develop quickly under favorable environmental conditions, and delaying applications of fungicides in these situations usually has little effect on the disease.

Because fungicides are subject to weathering, they must be reapplied at regular intervals when disease organisms are active to keep plants adequately protected. Growers using certified organic gardening practices can only use certain brands of sulfur or fixed copper from the fungicide options listed on Table 18, and they should be used very sparingly. Other organically approved fungicides exist though they may be difficult for the home gardener to find or are only available via mail order. Some of these organic fungicides include naturally occurring soil fungi that are antagonistic to disease-causing pathogenic fungi, and when applied can kill or out compete the pathogenic fungi. Other organic fungicide products include potassium bicarbonate (baking soda), or various horticultural oils, which may have a strong preventative effect against powdery mildew disease.

Chemicals should be applied only in the prescribed manner as recommended by the manufacturer. Read the label carefully and follow directions. Note the number of days required between the last fungicide application and harvest date. The waiting period may vary among crops.

All pesticides listed in Table 18 are registered for use in vegetable gardens as of November, 2015. Listing a fungicide is not a recommendation that pesticides are the primary control method suggested. Recent changes in pesticide registrations have significantly reduced the number of chemicals labeled for use in home vegetable gardens. Because labels may change at any time, information listed here may not be accurate. The user must accept responsibility for safe and legal pesticide use.

Measuring Tables for Mixing Small Quantities of Pesticide

Pesticides that are bought in large packages or sizes usually do not include instructions for mixing smaller amounts of a spray. Table 20 compares various measurements that are needed to make smaller amounts of a spray.

The powdered pesticide table (Table 21) can be used to mix different amounts of spray of the same mixture when using wettable powders. Example: If the label specifies that 3 pounds of a wettable powder pesticide material are to be added to 100 gallons of water, then 3 T of the pesticide material would make 1 gallon of similar spray mixture.

Table 18. Fungicides for use in the home vegetable garden (as of December, 2015).

| Active Ingredient: Trade Name | Vegetables ² | Remarks ² |
|--|--|---|
| Bordeaux Mixture: Bonide Garden Dust | Beans, beets, carrots, cucumbers, onions, peas, peppers, potatoes, squash, tomatoes | Apply to foliage for suppression of many foliar diseases. Must be used preventively. |
| Chlorothalonil: Bonide Fung-onil Multipurpose, Dragon Daconil, Hi-Yield Home & Garden Fungicide, Monterey Vegetable Fungicide, Ortho Daconil, Ortho Garden Disease Control | Beans, broccoli, Brussels sprouts, cabbage, carrots, cucumbers, cauliflower, corn, melons, onions, potatoes, pumpkins, squash, watermelons | Apply preventively to foliage, stems, fruit to control leaf spots & certain fruit rots. Will suppress powdery mildew. |
| Copper fungicides (fixed copers): Bonide Copper Spray or Dust, Bonide Liquid Copper, ³ Hi-Yield Copper Fungicide, Southern Ag Neutral Copper, Ortho Elementals Garden Disease Control ³ | Beans, beets, broccoli, Brussels sprouts, cabbage, carrots, cucumbers, eggplant, greens (collard, mustard, turnip) melons, okra, onions, peas, peppers, potatoes, pumpkins, spinach, squash, tomatoes, watermelons | Apply preventively to foliage and fruit to control bacterial diseases, downy mildew, and powdery mildew. May be phytotoxic under certain weather conditions. |
| Mancozeb: Bonide Mancozeb Flo w/zinc, Southern Ag Dithane M-45 | Asparagus, corn, cucumbers, melons, onions, potatoes, squash, tomatoes | Apply to foliage preventively to control a broad range of fungal diseases. |
| Myclobutanil: Spectracide Immunox | Asparagus, cucurbits, snap bean, tomatoes | Apply to foliage to control powdery mildew, rust, and other fungal diseases. |
| Neem and horticultural oils: Bonide Bon-Neem II, Bonide Neem Oil Concentrate, ³ Monterey All Natural Disease Control RTU, ³ Monterey Neem Oil RTU | Many—refer to label. | Apply to foliage to suppress powdery mildews. Use caution under conditions of plant stress. |
| Phosphorous acid: Monterey Agri-Fos | Asparagus, beans, broccoli, Brussels sprouts, cabbage, carrots, cauliflower, collards, cucumbers, eggplant, kale, lettuce, melons, mustard, peas, peppers, potatoes, squash, sweetpotatoes, tomatoes | Systemic product for downy mildew, Pythium damping off, and late blight management. Most effective when applied preventatively, refer to label for specific application instructions. |
| Sulfur: Bonide Sulfur Plant Fungicide, ³ Ferti-Lome Dusting Sulfur, Ortho Essentials 3-in-1 Rose and Flower Care ³ | Many—refer to label. | Effective against powdery mildew. May cause injury under hot & humid conditions. |

¹ Partial listing of products; see "Homeowner's Guide to Fungicides" (PPFS-GEN-07) at http://www2.ca.uky.edu/agcollege/plantpathology/ext_files/PPFShtml/PPFS-GEN-07.pdf.

² Product labels differ between manufacturers. Refer to product labels to ensure that the crop and disease to be controlled are listed.

³ Approved for use in organic gardens.

Different amounts of a similar spray can be made from the liquid pesticide table, when liquid pesticide materials (emulsifiable concentrates or EC) are used. When reducing the amount of a spray mixture, be sure to stay in the right column and line as indicated in Table 22. (T = tablespoon, t = teaspoon)

Symptoms of Some General Diseases and Their Management

Root Knot (nematode)—Galls and swellings on roots; plants grow poorly, may be stunted and wilt; tubers and fleshy roots may show lumps and swellings; affects wide variety of garden vegetables. Rotate with tall fescue or other grasses for several years; use resistant tomato varieties.

Southern Blight (Southern Stem Blight) (fungus)—Decay of lower stems near ground line, often with heavy, white fungal growth on stem; top of plant may wilt and die; affects peppers, tomatoes, beans, cucumbers and related crops. Rotate crops; turn under old plant debris early to allow for decomposition. Control defoliating diseases to prevent dropped leaves from serving as a food source for fungus. Consider creating a physical barrier to infection by the southern blight fungus. This can be accomplished by wrapping the lower stems of susceptible plants like pepper and tomato with aluminum foil so that the lower (below-ground) portion of the stem and 2-3 inches of the above-ground portion are covered.

Virus and Virus-Like Diseases (virus)—Symptoms vary—may be mottling, mosaic or yellowing of leaves or fruits; some viruses cause deformed shape of leaves, fruit or growing shoots; can sometimes be confused with nutritional or herbicide injury problems. Use resistant varieties when possible; there are varieties of beans resistant to the bean mosaic viruses and cucumbers resistant to cucumber mosaic; be aware that some plants have resistance to virus strains not present in your garden; many viruses persist in weeds and are carried to the garden by insects, especially aphids and leaf hoppers; control of insects and removal of weeds will decrease the threat of virus infection; use virus-free seeds and transplants; spacing planting dates often helps prevent virus infections. Overlapping of plantings favors virus buildup in later crops.

Insect Control

Insecticidal Soaps

Insect control begins with regular monitoring of plants to recognize the earliest signs of pest infestations. At a minimum, gardeners should inspect plants weekly for insect pests and be able to recognize the common pests. Many pests feed on the undersides of leaves, so gardeners need to flip over leaves when monitoring for pests.

Chemical control of insect and mite pests should be the last tactic and only used when needed. Other techniques to reduce the impact of insect and mite pests include:

- Using recommended planting dates and other horticultural recommendations will help to produce plants that can be more tolerant of pests.
- Do not over fertilizing plants, as this may make them more susceptible to aphids.
- Control weeds in the garden as they can harbor many types of vegetable pests and pathogens they can transmit to vegetable plants.
- If only a few pests are seen, handpick them and toss them in soapy water.
- Consider using row covers over seedlings or small transplants.
- Use insecticides only when needed.
- Read, understand and follow label directions with insecticides.
- Make sure the vegetable being treated is on the label.
- Use appropriate personal protective equipment when using pesticides to minimize exposure.
- Check labels for the minimum time between application and when produce can be harvested.
- Avoid spraying plants (or weeds!) in bloom in ways that will harm pollinators.

Insecticidal soaps can be used to control aphids, mealy bugs, scale and mites. The spray must completely coat insects and plants to be effective. Follow directions on the package for dilution and method of use.

Horticultural Oils

These ultra-fine oils are used to control aphids, mites, leafminers, thrips, leafhoppers and whiteflies on certain vegetable crops.

All spoons, cups or other measuring utensils used to measure any pesticide or other chemicals must be clearly marked with red paint and kept in the storage cabinet.

Table 19. Measuring abbreviations.

| | | | |
|----------|--------------------------|----|-------|
| WP | wettable powder | | |
| EC | emulsifiable concentrate | | |
| D | dust | | |
| G | granular | | |
| Sol | solution | | |
| t or tsp | teaspoons | | |
| T or Tbs | tablespoon (level) | | |
| C | cup | lb | pound |
| gal | gallon | oz | ounce |
| qt | quart | fl | fluid |
| pt | pint | | |

Table 20. Measurement comparisons.

| |
|--|
| 3 tsp (level) = 1 Tbs (level) |
| 2 Tbs = 1 fluid oz = 6 tsp |
| 4 Tbs = 12 tsp = ¼ cup = 2 fluid oz |
| 1 cup (level) = 16 Tbs = 8 fluid oz |
| 2 cups = 32 Tbs = 1 pt = 16 fluid oz |
| 2 pt = 64 Tbs = 1 qt = 4 level cups |
| 4 qt = 8 pt = 1 gal = 16 cups |
| 16 oz = 1 lb |
| 6 Tbs = approx. 1 oz of dry weight (WP only) |

Table 21. Powdered pesticide.

| Water | Quantity of Powdered Pesticide Material Needed | | | | | |
|---------|--|------|------------|-------------|-------------|-------|
| 100 gal | 1 lb | 2 lb | 3 lb | 4 lb | 5 lb | 6 lb |
| 25 gal | 4 oz | 8 oz | 12 oz | 1 lb | 1¼ lb | 1½ lb |
| 5 gal | 5 T | 10 T | 15 T (1 C) | 20 T (1¼ C) | 25 T (1½ C) | 1¾ C |
| 1 gal | 1 T | 2 T | 3 T | 4 T | 5 T | 6 T |

The above measurements of wettable powder are acceptable for practical purposes.

Table 22. Liquid pesticide.

| Water | Quantity of Liquid Pesticide Material Needed | | | | | |
|---------|--|---------------|---------------|---------------|---------------|----------------|
| 100 gal | ½ pt | 1 pt | 2 pt | 3 pt | 4 pt | 5 pt |
| 25 gal | 2 fl oz | 4 fl oz | 8 fl oz | 12 fl oz | 1 pt | 1¼ pt |
| 5 gal | 1 T | 2 T (1 fl oz) | 4 T (2 fl oz) | 6 T (3 fl oz) | 8 T (4 fl oz) | 10 T (5 fl oz) |
| 1 gal | ½ t | 1 t | 2 t | 3 t | 4 t | 5 t |

For amounts of spray not listed, the tables can be halved, doubled or added to get any combination needed.

These oils may be phytotoxic at high temperatures (> 100°F) and are incompatible with some other pesticides, so read and follow directions on the package before use. Complete coverage is necessary for oils to be effective. Do not confuse these horticultural oils with dormant oils. Dormant oils are usually toxic to foliage.

Botanical Insecticides

Some insecticides come from natural plant materials and are thus allowed for certified organic growers.

Pyrethrum is the generic name given to a plant based insecticide derived from the powdered, dried flower heads of the pyrethrum daisy, *Chrysanthemum cinerariaefolium*. Pyrethrum is a fast acting contact poison that 'knocks down' susceptible insects.

Neem products are derived from the neem tree, *Azadiracta indica*, native to southern Asia, and are usually made by crushing neem tree seeds, then using water or a solvent such as alcohol to extract the pesticidal constituents. Other products are made from cold-pressed neem seed oil or from further processed neem oil. Neem is a broad-spectrum insecticide, which works by contact or ingestion, and acts mainly as an insect growth regulator, but also has anti-feedant and oviposition (egg-laying) deterrent properties.

Rotenone is a pesticidal compound found in several subtropical leguminous shrubs. It is a slow-acting poison which is toxic to many species of insects in many different insect orders (caterpillars, beetles, flies, etc.). Rotenone is quickly degraded in sunlight. No Rotenone products are currently approved for certified organic production.

Floating Row Covers

The floating row cover material mentioned on page 15 is useful for season extension also can play a major role in protecting plants against insect attack. Use the thinnest row cover fabric available and seal the edges after transplanting to ensure insects cannot get to their target plant. Many crops, like turnip greens and eggplant, can be grown all the way to harvest without ever removing the fabric except to control weeds or apply side dress fertilizers. The fabric is reusable over multiple growing seasons and when used properly can totally eliminate all insecticidal sprays that might be necessary for certain crops.

Soil Insects

Cutworms—Cutworms are dull-colored, smooth caterpillars that cut off plants above, at or below ground level. Some climb plants and feed on leaves, buds or fruit. Underground types are particularly destructive to young pepper, tomato, cabbage, pea, bean and squash plants.

Use a 6-inch diameter cardboard collar 3 inches high, pushed into the soil 1 inch after planting transplants. You can also broadcast carbaryl (Sevin) 5% bait or esfenvalerate over cutworm infested areas. Prepare beds and eliminate weeds at least two weeks before planting. Bait formulations, sometimes using bran or applying rolled oats with molasses containing *Bacillus thuringiensis* var. *kurstaki*, have been known to effectively control cutworm species when applied to the soil.

Root Maggots—There are several kinds of root maggots, including seed-corn maggot, cabbage maggot and onion maggot. They are whitish, legless, somewhat peg-shaped and without a distinct head. They tunnel roots, stems, bulbs or seeds and cause rot in the injured parts. Adults resemble house flies in appearance.

For onion maggots, spray foliage with malathion when flies are present. You can buy insecticide-treated bean, pea and corn seeds that will give protection against seed maggots. Delay planting until soil conditions favor rapid germination of seeds and avoid sowing seed too deeply to minimize losses to seed-corn maggots. Apply diatomaceous earth around the base of the seedlings at planting and following each rain early in the season. Thin floating row covers can prevent infestation by root maggot populations when placed over transplants or seedlings.

Sowbugs—Sowbugs are insect relatives that roll into a ball when disturbed. They feed mostly on decaying organic matter, but also damage root hairs, or ripe tomatoes resting on the ground. Heavily mulched gardens and areas near compost heaps usually have more problems with this pest.

Clean up ground litter under which sowbugs hide during the day. Don't compost next to the garden. Broadcast carbaryl (Sevin) 5% bait in infested areas.

White Grubs—White grubs are C-shaped larvae, ½ to 1 ½ inches long, whitish with hard, brown heads. They are found most often in high humus soil or gardens previously in sod. They feed on roots and tubers. The adults are May beetles or Japanese beetles.

Wireworms—Wireworms are yellowish to whitish, hard-bodied worms resembling a jointed wire. They puncture and tunnel roots or tubers of beans, carrots, beets, celery, lettuce, onions, potatoes, sweet potatoes and turnips. The adults are click beetles.

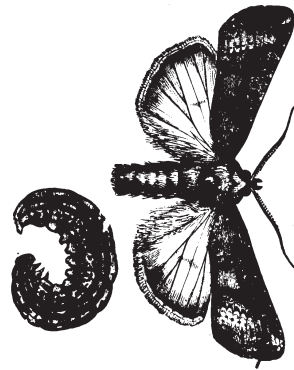

Figure 18. Cutworm.

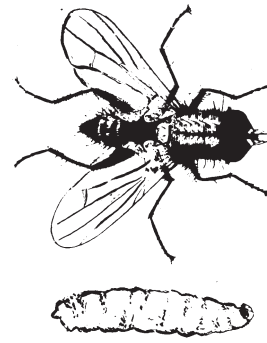

Figure 19. Root maggot.

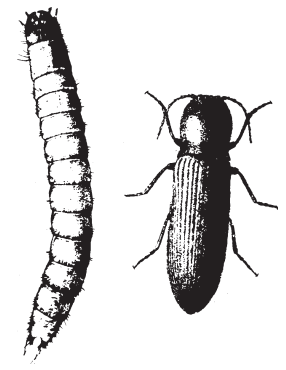

Figure 20. Wireworm.

Avoid planting susceptible crops in soil that has been in sod for one to two years.

Borers

Corn Earworm—Corn earworms are also called tomato fruitworms. They are green, brown or pink caterpillars with light stripes along the sides and back and are up to 1 ¼ inches long. They eat holes in the fruit of tomatoes, peppers, okra and beans, and they burrow through silk to feed on kernels of sweet corn. Early in the season they feed on the central shoot of corn. They may also attack other crops. Losses to corn earworm can be minimized by avoiding late planting of sweet corn (after June 1). Generally, corn needs to be protected from this pest while fresh silks are present.

For earworm control on sweet corn, apply 20 drops of vegetable or mineral oil mixed with the recommended rate of *Bacillus thuringiensis* (Bt) with a medicine dropper to silks inside tip of ear after silks have wilted (3 to 7 days after silks first appear).

Squash Vine Borers—Squash vine borers attack the vines and fruit of squash and related plants. The adult moth resembles a wasp and is a daytime flier.

Select an insecticide from those listed on page 41. Two to three insecticide applications are needed 7 to 10 days apart beginning after the vines begin to run. A curative method for the squash vine borer in its hosts is to split the vine lengthwise, remove the borer, bind the split stem together again and keep the plant watered. Destroy crop residues shortly after harvest.

European Corn Borer—The European corn borer is best known for its attack on stalks, but it is also a common pest of pepper fruits. It bores in near the cap. Water gets into the fruit through the borer hole, and the fruit rots. It is also a common borer in potato vines and other plants when populations are high.

Figure 21. Corn earworm.

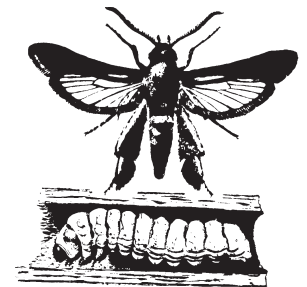
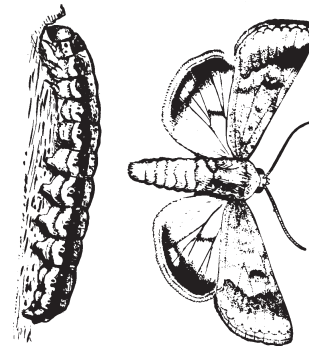

Figure 22. Squash vine borer.

Figure 23. Aphid.

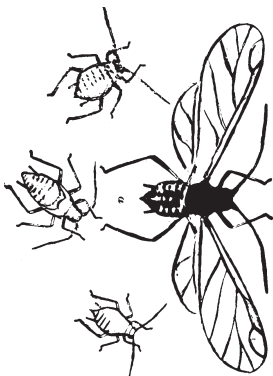

Figure 25. Leafhopper.

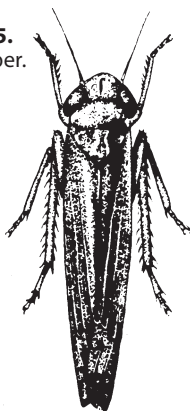

Figure 24. Mite.



Sucking Insects

Aphids—Aphids are black, red or green, soft-bodied insects grouped in colonies on leaves and stems. Most individuals in a colony are wingless. By sucking the sap, they cause leaves to wilt, curl, pucker, stunt or yellow. Aphids produce “honeydew” which falls on leaves, making them sticky. Sooty mold may develop on honeydew deposits. Some aphids transmit viruses. Some whitish or bluish aphids also feed on beet roots but do not seem to be a serious problem.

Early season sprays of malathion give good control. Organic gardeners can use insecticidal soap, neem based products, or horticultural oil for aphid control. Yellow-colored card traps covered with a sticky glue substance are useful against aphid as they are attracted to the color yellow.

Greenhouse Whitefly—The greenhouse whitefly is a tiny, powdery white insect that flutters from foliage when infested plants are disturbed. The immature stages resemble tiny green scales on leaf undersides. Infested plants lack vigor. Leaves wilt, turn yellow and are often covered with sooty mold growing on whitefly honeydew. Tomato, eggplant, squash and certain weeds are favorite hosts in the garden. The whitefly cannot overwinter outdoors at our latitude, so garden infestations begin from infested transplants or escapees from greenhouses.

Control garden weeds and buy only clean transplant material. Doubtful transplants should be watched closely and treated with malathion spray at the first sign of infestation. If the infestation is well established, four or more sprays at weekly intervals may be needed. Heavy infestations late in the season are almost impossible to control. Yellow-colored card traps covered with a sticky glue substance are useful against whitefly as they are strongly attracted to the color yellow. Sprays of insecticidal soap or horticultural oil are also effective.

Bugs

There are many species of bugs in various sizes, shapes and colors. Stink bugs, including the harlequin bugs, are shield-shaped. The harlequin bug is orange and black. Most of the other stink bug pests are solid green or brown. The color patterns of young stink bugs differ from that of the adult. Harlequin bugs wilt cabbage and turnips; leaves turn brown as if scalded. Other stink bugs cause warts on bean and okra pods, and tomato fruit may be malformed. Squash bugs are oblong and brown, but the young are gray. They attack only squash, pumpkins, gourds and melons in that order of preference.

There is a new stink bug, the brown marmorated stink bug, that is both a winter home invader and a very serious summer garden pest attacking beans, tomatoes, peppers, sweet corn, eggplant, okra, and other vegetables. This insect can build to very high numbers in some years. As this is primarily a pest attacking the fruit part of the plant, netting or row covers can be used to protect after bloom. Malathion or pyrethroids are used to reduce numbers of this pest.

The group of bugs known as plant bugs are usually oval and somewhat flattened. The plant bug group includes lygus bugs, the tarnished plant bug and the four-lined plant bug as well as many others. Plant bugs feed on pods, stems, blossoms and leaves. Attacked pods often drop, or the seeds are pitted and undesirable for food. Leaf feeding may cause dead spots that resemble leaf spot disease symptoms.

Control weeds that are alternate hosts. Apply an appropriate insecticide from the table following this general discussion when bugs are present. Destroy crop residues immediately after harvest.

Mites—Mites are tiny, eight-legged relatives of insects found on leaf undersides and are barely visible to the naked eye. Infested leaves are very finely speckled or “bronzed,” giving them a dusty look. If badly infested, the leaves are covered with very fine cobwebs. Beans, cucumbers, melons and tomatoes are most often attacked. Mite outbreaks are more common during hot, dry periods.

Spray with malathion when injury first appears and repeat as needed. The webbing may be broken up by strong hosing of infested plants with water. This may provide some reduction of the problem. Insecticidal soaps provide effective mite control when used properly and complete coverage is obtained.

Thrips—There are several important species of thrips, but only the onion thrip is apt to be a problem. It is yellowish or brown, tiny (only 1/25 inch long), and winged. Young onion thrips are tinier, white and wingless. Thrips take sap from onion foliage, causing white blotches. Tips of foliage wither and turn brown.

Control with esfenvalerate or malathion. Insecticidal soap mixed with horticultural oil and botanical insecticides that include Neem oil have been somewhat effective.

Leafhoppers—Leafhoppers are tiny, pale green, wedge-shaped, active insects that are mostly pests of potatoes, beans and lettuce. Immature leafhoppers resemble the adults and move sideways when disturbed. By sucking the sap, they cause bean leaves to curl downward and turn yellow. Plants may be stunted or killed. On potatoes, the tips and sides of leaves curl upward, turn yellow to brown and get brittle. Aster yellows virus is spread to lettuce by leafhoppers.

Plant lettuce near hedges or other sheltered areas. Apply malathion or carbaryl sprays weekly as needed. Control weeds that may host leafhoppers and harbor viruses, or treat weeds along with the crops for leafhoppers. Botanical insecticides based on Pyrethrum and Neem have shown fair control of this pest.

Chewing Insects

Asparagus Beetle—The asparagus beetle is 1/4 inch long and black with yellow markings. The larva is olive green and 1/3 inch long. The eggs look like tiny black pegs on spears and stems. Adults and larvae eat asparagus foliage and disfigure spears.

Mexican Bean Beetle—The Mexican bean beetle is coppery to yellow with 16 black spots on its back and is 1/4 inch long. Larvae are yellowish, spiny, up to 1/2 inch long and are found on the under-

sides of leaves. Adults and larvae skeletonize bean foliage and feed on pods. While most lady beetles feed on other insects, the Mexican bean beetle is only a plant feeder. Use Sevin as necessary for control. Mexican bean beetles can be excluded from small bean plantings using thin floating row cover material. Handpicking of beetles is also useful for small plantings. Neem based botanical insecticides have some effect.

Cucumber Beetle—There are two species of cucumber beetles. They are yellowish-green, with one species having black stripes and the other black spots. Besides cucumbers, the flowers and leaves of many other vegetables and flowers may be attacked. Cucumber beetles spread bacterial wilt in cucumbers. The larva of the spotted species is also a rootworm of corn and other plants. Early control of cucumber beetles on cucumbers and melons beginning at plant emergence is necessary to reduce bacterial wilt transmission. Cucumber beetles can be excluded from melon/squash/cucumber plantings using thin floating row cover material to cover the plants until harvest. Row covers may have to be opened when the plants are flowering to ensure pollination. Imidacloprid used at planting or the day of transplanting will provide a month of control.

Japanese Beetle—The Japanese beetle is metallic green with copper wing covers. It is ½ inch long. The larvae are white grubs in sod. The adults coarsely skeletonize the foliage of beans and okra, and feed on the foliage and silks of corn. Use Sevin as necessary for control. Thin floating row cover can exclude Japanese beetles from plants. Botanical insecticides based on Pyrethrum have shown fair control of this pest.

Colorado Potato Beetle—The Colorado potato beetle is a yellow, black-striped, robust beetle, ½ inch long. Larvae are brick red, humpbacked and up to ⅓ inch long. Adults and larvae defoliate eggplant, potato and tomato. There are two generations per year. Hand-picking of the adults in the spring or effective control of the first generation with sprays helps to reduce the more troublesome summer generation. Adding mulch around potato plants before adult beetles arrive has shown to limit infestation. Neem based botanical insecticides have some effect.

Bean Leaf Beetle—The bean leaf beetle is reddish to yellow, ¼ inch long, with black spots on its back. Adults eat regularly shaped

Figure 26. Mexican bean beetle.

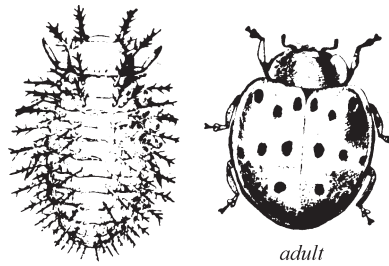

Figure 27. Cucumber beetle.

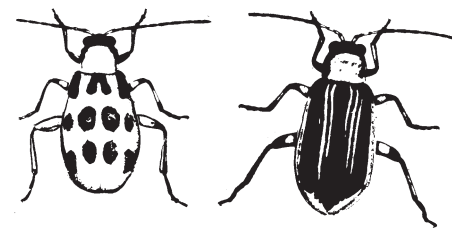

Figure 28. Japanese beetle.



Figure 29. Colorado potato beetle.



Figure 30. Flea beetle.

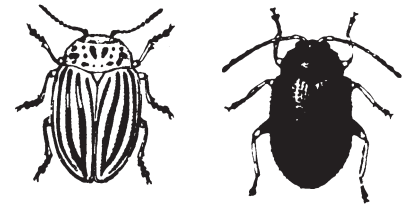

holes in pea, bean and cowpea leaves, while larvae feed on the plant's root system. Use Sevin as necessary for control. Bean leaf beetles can be excluded from small bean plantings using thin floating row cover material. Handpicking of beetles is also useful for small plantings. Neem based botanical insecticides have some effect.

Blister Beetle—There are several species of blister beetles. They are black or gray, sometimes with yellow stripes, soft-winged and ¼ to ½ inch long. They eat foliage of various vegetable crops, including potato, tomato and beets.

Flea Beetles—Flea beetles are tiny jumping beetles about ¼ inch long. There are many species. They eat shot holes in potato, tomato, eggplant, pepper, beet, spinach, turnip, radish, cabbage and other crops. Young transplants are often damaged severely. Use Sevin as needed for control. Thin floating row cover can exclude flea beetles from plants and can be left in place until harvest on most crops. Other botanically based insecticides that include Pyrethrum or Neem allow only fair control.

Grasshoppers—There are a number of species of grasshoppers, and when they are a problem Sevin can be used for control.

Imported Cabbageworm—The imported cabbageworm is a velvety green caterpillar up to 1 ¼ inch long. The adult is a white butterfly with black markings on the wings. The caterpillar eats ragged holes in cabbage leaves and bores into the head. Larvae are com-

Figure 31. Imported cabbageworm.



Figure 32. Cabbage looper.



Figure 33. Hornworm.



Table 23. Spray Dilution Chart.

| | Amount per Gallon | Notes |
|------------------|-------------------|---|
| Sevin 50% WP | 2 T | See the label for the number of waiting days from the last application of insecticide to harvest. |
| Malathion 57% EC | 2 t | |
| Captan 50% WP | 2 T | If different concentrations (% WP or EC) of any of these fungicides or insecticides are used, be sure to follow label directions for the amount to use per gallon of water. |
| Zineb 75% WP | 2 T | |
| Maneb 80% WP | 2 T | |
| Mancozeb 80% WP | 2 T | |
| Karathane 25% WP | 1 t | |
| Bravo 75% WP | 1 T | |
| Bravo 500 | 2-3 T | |
| Fixed Copper | 1 ½ T | |

monly found near the developing bud of the plant. Sprays containing *Bacillus thuringiensis* are effective.

Cross-Striped Cabbageworm—The crossstriped cabbageworm is a caterpillar up to ½ inch long with many fine, black, transverse lines across a bluish-gray back. It has a yellow stripe along each side and a light green, mottled underside. It prefers buds and heads of cabbage, but attacks all cole crops. *Bacillus thuringiensis* sprays are effective.

Cabbage Looper—The cabbage looper is a pale-green caterpillar with light stripes down the back. It is up to 1 ½ inch long and humps up or loops when it crawls. It eats ragged holes in many kinds of plants, but particularly cole crops. It also burrows into cabbage heads. This pest is more common with fall plantings.

Armyworm—Armyworms are caterpillars similar to cutworms that feed on a wide variety of plants, generally grasses. These may be a problem with early sweet corn plantings. After defoliating a food source, they may move in large masses to new areas.

Hornworm—Hornworms are green caterpillars up to 4 inches long with diagonal white lines on the sides and a prominent horn on the rear end. They defoliate tomato, eggplant, potato, tobacco and related weeds. Sprays containing *Bacillus thuringiensis* are effective against hornworms.

Weed Control

Weeds compete with desirable garden plants for water, nutrients, sunlight, and space needed for growth. Weeds also harbor diseases and insect pests that attack vegetable plants. The following measures will help you avoid a weedy garden:

- Prevent garden weeds from going to seed. Some weed seed can remain viable for 20 years or more.
- Keep border areas around the garden free of weeds.
- Clean equipment to prevent weed seeds or plant parts from being transported into clean areas.
- Do not mulch with hay containing grass or weed seeds.
- Avoid using manure unless it has been sterilized or well composted.
- Avoid using soil infested with weeds or weed seeds.
- Avoid buying transplants that are weedy.
- Purchase high-quality vegetable seeds free of weed seeds.

When soil and growing conditions are as ideal as possible and the plants selected are adapted to the soil conditions, garden plants may have a competitive advantage over weeds. No better way of controlling garden weeds exists than having vigorous, desirable plants crowding them out.

Starting Right

Identify your garden site as early as possible and eliminate any perennial weed problems prior to planting. Perennial weeds are those that come back year after year and can reproduce vegetatively through runners, stolons, tubers, etc., as well as by seed. If necessary delay planting one year until you have eliminated those perennial weeds. If you have a site that is suitable and you don't have any perennial weeds, consider solarization. Solarization is using clear plastic over the site prior to planting to warm the soil and cause a rapid flush of weed germination. This is usually done about 3 weeks prior to planting and will give you an opportunity to control many of the annual weed seeds that would germinate and compete with your garden crops.

Controlling Weeds by Hand

Weeding the garden by hand is the oldest form of weed control and is still quite practical in small areas. A major advantage of hand weeding is that no equipment, other than a hoe or hand trowel, is needed. Hand weeding is a good exercise for the heart and a great sense of accomplishment for the soul. However, it is time consuming and only temporarily effective. It must be repeated several times throughout the growing season to assure continuous weed control. Weeding also helps the gardener regularly check plants for early signs of insect and disease problems.

If you decide to weed by hand, a few tips can make it more efficient and possibly even enjoyable. Use high quality, ergonomically designed tools to lessen the strain on your back, wrists, knees. Make sure the hoe blade is clean and sharpened before each use. A sharp hoe will cut the weeds rather than rip them out of the soil and can save a lot of sore arms. Shave off the weeds near the soil surface while they are still small (less than 2 inches) and gently break up the crust. Don't till too deep or you may injure shallow-rooted garden plants and turn up a fresh supply of weed seeds which will germinate. Power equipment such as a rototiller probably cannot be set shallow enough for this type of weed control. For bigger weeds, a rototiller is useful especially in the area between rows.

Mulching for Weed Control

Both organic and inert mulch materials may be used to provide season long control of garden weeds. Advantages and disadvantages of various mulches are discussed in "Caring for Your Vegetables During the Growing Season" under "Mulching."

Chemical Weed Control

Hand weeding and mulching are more preferable than herbicide use in the home garden, because herbicides which can be safely used with some crops may severely damage more sensitive ones. They also may remain in the soil and damage future plantings. Herbicides, however, provide effective weed control where substantial areas of single or related crops are grown. Even so, their use should be complemented with hand weeding and/or mulching.

For any seed, including weed seed, to germinate and grow, three soil factors must be present in the proper ratio: soil moisture, optimum temperature, and oxygen. These factors normally occur in an optimum combination near the soil surface where weed seeds are located. That is, optimum conditions for weed seed germination and subsequent growth occur in the top 1 inch of soil. Because weed seeds are near the soil surface, any hand weeding or tilling after herbicides are used should be as shallow as possible. Follow these points for successful use of herbicides in the home garden:

Plan the garden in advance—Group crops according to their herbicide tolerance, i.e., group in one area all crops for which one herbicide is recommended. This grouping lets you treat larger areas with minimum effort.

Apply at the right time—Understand that most garden herbicides are termed "preemergence." That is, they should be applied to a clean tilled soil surface before weed seeds germinate. They do not have an effect once weeds have already emerged.

Know what weeds you have—Herbicides may control one species of weed and not another. There are good weed identification guides available.

First prepare the soil—Before applying a preemergence herbicide, till the soil to remove existing weeds and work out all clods, leaving the soil surface as smooth and level as possible.

Follow the label directions very carefully—THE LABEL IS A LEGAL DOCUMENT. Apply preemergence herbicide accurately and uniformly. Uneven application may result in poor weed control or may injure present or subsequent crops. Check amounts of the material to be used and read carefully the application techniques on the container label.

Apply the herbicide on moist soil—When using most preemergence herbicides, about ½ inch of rainfall is needed within seven days of application for optimum weed control. If not enough rain has fallen within seven days, apply ½ inch of water by way of overhead irrigation. Do not use furrow irrigation as it will wash out the herbicide and reduce its effectiveness.

Sprayer types—The simplest and most reliable sprayer for application of home garden herbicides is the 1- or 2-gallon compressed air sprayer. These sprayers are simple to operate, inexpensive and provide uniform application of the herbicide. *It is highly recommended that you assign one sprayer for exclusive herbicide use and another for insecticide or fungicide use.*

If the label does not specify the water volume to use, a general rule of thumb for best distribution over the entire area is to use 1 gallon of the herbicide-water mixture per 400 square feet of soil surface. This volume should be sprayed evenly over the 400 square feet. Square footage is figured by multiplying the length of the garden by the width of the garden. For example, a 20 ft x 20 ft garden = 400 square feet; or a 10 ft x 40 ft garden = 400 square feet. Do not guess distances and/or areas to be sprayed. Accurately measure or weigh the amount of herbicide that is to be added to the sprayer. Practice with water only for several times if you have not sprayed pesticides previously.

Granular herbicides—Some garden herbicides are available as granular materials in shaker-type containers. These are the easiest formulations for most home gardeners to apply since they do not need to be mixed with water for application. As with all herbicides, use these exactly as the label directs. After sprinkling the granular material over the treatment area, use a rake to lightly incorporate the herbicide into the soil.

Cleaning equipment—Rinse all spray equipment thoroughly inside and out after each application and run plenty of clean water through the hose and nozzle. Never use growth regulator or

phenoxytype herbicides such as 2,4D in or around the home garden. These herbicides cannot be cleaned out of sprayers thoroughly enough to avoid injury to vegetable crops. Do not use sprayers in the garden which have been used to apply these herbicides to lawns. Be careful of drift onto the garden when spraying your lawn.

Where to purchase—Home garden herbicides can generally be purchased at nurseries, garden centers, or garden supply stores. In smaller communities and in rural areas, the homeowner may be able to purchase these materials from farm supply stores, hardware stores, and drugstores or through mail order nursery and seed catalogs.

Use herbicides with caution—Follow the manufacturer's directions to the letter when measuring, mixing, or applying them. Read the label carefully for the names of plants that product can be safely used. Heed all other warnings and note precautions. If you have any questions, consult your Extension agent for agriculture.

Garden Herbicides

The following section includes the trade name and formulation of one of the readily available garden herbicides. It would be impossible to list all the potentially available home garden products as the list changes on a yearly basis. Since rates and methods of herbicide application vary from one formulation to another, be sure to read the product label for complete application instructions before application.

CHEMICAL NAME: Trifluralin

TRADE NAME: Greenview Preen, 1.47% granules. There are several other formulations that contain trifluralin.

PLANT: Asparagus (established beds), Lima and Snap beans, Broccoli (transplants), Brussels sprouts (transplants), Cabbage (transplants), Cantaloupes, Cucumbers, Carrots, Cauliflower (transplants), Celery, Collards, Okra, English and Snap peas, Southern peas (cowpeas, field peas, blackeyed peas), Peppers (transplants), Potatoes, Tomatoes (transplants), and Watermelons.

REMARKS AND LIMITATIONS: For control of annual grasses such as crabgrass, foxtail, and goosegrass, and broadleaf weeds such as pigweed and lambsquarters. Remove existing weeds prior to application. Mix thoroughly into the top 1 to 2 inches of soil. Read and follow label directions for use on each crop. Other crops not listed here may be easily injured.

Storing Vegetables

Vegetables do not improve in quality after harvest. Therefore, harvesting sound, healthy produce at the proper stage of maturity is important. Produce that will be stored must be harvested carefully to avoid bruising and to maintain quality. Breaks in the skin enable decay organisms to enter the produce and also increase moisture loss.

Vegetables and fruits can be grouped in four basic storage groups:

- The cool- and cold-moist groups may be stored in an old-fashioned outdoor pit or underground root cellar.
- The cold- and cool-dry groups can be stored in a cool area of a basement or garage.

Table 24. Produce storage conditions.

| Produce Category | | Storage Temp. (°F) | Relative Humidity | Storage Period |
|------------------|-----------------------------|--------------------|-------------------|----------------|
| Cold-Moist | Broccoli | 32 | 95% | 3 weeks |
| | Cabbage (late) | 32 | 95% | 3-4 months |
| Cool-Moist | Irish potato (late) | 40 | 85-90% | 4-6 months |
| | Sweet potato (after curing) | 55 | 85-90% | 4-6 months |
| | Tomato (mature green) | 60 | 85-90% | 1-4 weeks |
| Cold-Dry | Onion | 32-35 | 60-70% | 2-8 months |
| Cool-Dry | Pumpkins | 50-55 | 60-70% | 2-4 months |
| | Winter Squash | 50-55 | 60-70% | 2-4 months |

While storage does not require investment in expensive equipment, it does demand an awareness of good food characteristics and periodic examination to remove defective produce.

Figure 34. Storing vegetables in the ground.

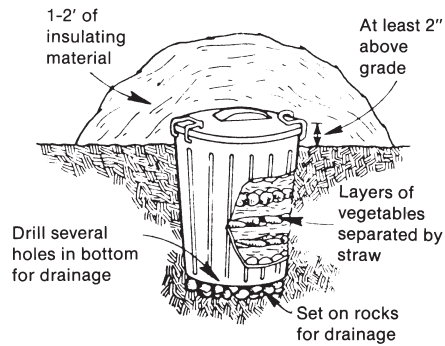

Generally, late-maturing varieties are better suited for storage. Garden crops held in storage are still living plants that are kept dormant by their environment. If these crops are subjected to adverse conditions like lack of oxygen, freezing, or excessive moisture, they can die or decay. Produce can tolerate less than optimum storage conditions, but storage life is shortened.

You can store some produce in the garden right where it grew. It may be protected from late fall frosts and freezing by insulating materials such as straw, dry leaves, sawdust or soil. Root crops such as carrots, turnips and parsnips will store well this way. When the ground begins to freeze in late fall, cover them with a heavy mulch of straw or dry leaves to make midwinter harvesting easier.

Beets, cabbage, Chinese cabbage, cauliflower, kale, leeks and onions can also withstand light frosts. They can be stored for several weeks under heavy mulch but usually will not keep through the winter.

Be sure to plant crops to be stored under mulch in a spot that is easily accessible for winter removal.

A 20-gallon trash container can be buried in the ground for storage and is more easily opened and closed than a soil mound or trench. Metal cans are more rodent proof than plastic. Drill

Table 25. Preservation methods for specific vegetables.

| Produce | Store | Can | Pickle/Preserve | Freeze | Produce | Store | Can | Pickle/Preserve | Freeze |
|-------------------------|----------------|-----|-----------------|----------------|----------------------|----------------|----------------|-----------------|--------|
| | | | | | | | | | |
| Asparagus | | | | x | Horseradish | x | | x | |
| Beans, Wax or Green | | x | | x | Kohlrabi | x | | | |
| Beans, Dry ² | x | | | | Parsley (dried) | x | | | x |
| Beets | x ¹ | x | x | | Parsnips | x | x | | |
| Broccoli | | x | | x ¹ | Peas | | x | | x |
| Brussels Sprouts | x | | | x | Peppers, Hot (dried) | x | | | |
| Cabbage | x ¹ | | x | | Peppers, Sweet | | x | | x |
| Cauliflower | x | | | x | Potatoes | x ¹ | | | |
| Celery | x | | | | Potatoes, Sweet | x | x | | |
| Chard | | | | x | Pumpkins | x ¹ | x | | |
| Chinese Cabbage | x | | | | Rutabagas | x | | | x |
| Corn | | x | x | x | Salsify | x | | | |
| Greens, Kale | x | | | | Tomatoes | x | x ¹ | | |
| Greens, Swiss Chard | | x | | x | Winter Radishes | x | | | |
| Greens, Spinach | | | | x | Winter Squash | x ¹ | x | x | |

¹ Preferred method

² Kidney, navy, white marrows, turtles

holes in the bottom for drainage (Figure 34). Leave 1 to 2 inches of the can above the soil level and use straw to cover the lid. A foam plastic chest also makes a good small produce storage container and can be kept in an unheated garage or building. Use separate containers for fruits and vegetables. Be sure the storage containers are clean so that they do not impart flavors or odors to the stored produce.

Basement areas near the furnace make an acceptable storage site for winter squash and pumpkins. Use a thermometer to monitor the temperature in various areas of a basement or building to find locations adaptable for good food storage.

Basement window wells which open inward and have exterior wells can be converted to small storage areas if the well is covered after the weather turns cool and is insulated with bales of hay or straw.

What You Should Know about Asparagus through Watermelons

Asparagus

Asparagus is a perennial vegetable that, once established, may live for 15 to 30 years. Locate asparagus to one side of the garden where it will not be disturbed. It is one of the most valuable early vegetables and is well adapted to freezer storage. The spears develop daily in early spring with the rate of emergence increasing as temperatures increase.

Planting—You can start asparagus from seed, although starting from one- to two-year-old crowns set in early March is recommended. One-year-old crowns or plants are preferred. The crowns are ac-

tually a combination of rhizomes, fleshy roots and fibrous roots. The fleshy roots, which may spread laterally under the soil several feet from the rhizomes, store food reserves that help develop the tender shoots the next spring.

Soil type determines the depth to plant crowns. Usually they are planted in a trench 12 to 15 inches wide and 6 to 8 inches deep. Plant at the shallower depth if the soil is heavy. Incorporate rotted manure or compost, plus fertilizer, into the soil before setting the crowns because little organic matter can be added later. Set plants 15 to 18 inches apart in rows 30 inches apart. Place the crown on a small amount of soil

in the trench, allowing it to be slightly higher than the roots. Spread the roots out and cover the crown with 2 to 3 inches of soil. Firm down well. As plants begin to grow, continue to put soil around and over the crowns until the trench is filled.

Harvesting—Asparagus shoots or spears should not be harvested the first year after crowns are set. Limit harvests the second year after planting to three to four weeks, then let the ferns grow. This procedure is necessary so that the root system will develop from its limited size and will store food reserves to produce growth the next year. Plants harvested too heavily too early after setting may become weakened

and spindly. After the third year, harvests can be continued for eight to ten weeks. Harvest spears daily when they are 5 to 7 inches tall. Break them off at the soil level instead of cutting below the soil surface. Cutting can easily injure the crown buds which produce the next spears. Harvest in early morning and use or refrigerate immediately.

Fertilizing—Each year in the early spring, sidedress asparagus with 1 pound or 2 cups of 5-10-10/50 feet of row. Apply 2 cups of 10-10-10 or similar fertilizer after harvest. Following freezing weather in the fall, remove the asparagus tops to decrease disease problems.

Diseases

Crown Rot, Wilt (fungus)—Plants gradually decline and die. Avoid acid soils and poorly drained sites. Maintain good fertility. Avoid excessive harvest.

Rust (fungus)—Reddish-black pustules on leaves and stems. Grow rust-resistant varieties. Spray with mancozeb (from harvest until August 15) or sulfur fungicides.

Insects

See pages 25-28 for insect descriptions.

| | |
|-------------------------|-----------------------------|
| Treatments | <i>(see footnote below)</i> |
| Aphids | 10, 11, 12 |
| Asparagus Beetles | 2, 3, 14 |
| Cucumber Beetles..... | 2, 3 |
| Cutworms..... | 9, 14 |
| Grasshoppers..... | 2, 9 |
| Sowbugs..... | 9 |
| Thrips | 10, 11 |

Beans

Beans grown for the pod, such as green snap beans, are the most common type of bean growing in the home garden, though some green beans are grown primarily for the bean itself and not the pod. Lima beans and edible soybeans are also popular. Beans are sensitive to cold temperatures and should not be planted until after the danger of frost is past in the spring.

The bush type is the most popular of the snap beans because it matures earlier and requires less space. Most varieties of bush snapbeans will have pods ready for harvest 50 to 60 days from seeding.

Pole type snapbeans require stakes, a trellis, a fence or some other type of support. They also require a few more days to mature their pods and they continue to bear over a longer period than the bush type varieties. They require about 65 days from seed to harvest.

Snap beans reach their best stage of edible maturity when the seed within the pod is about one-third developed.

Varieties of shell beans are more suitable for shelling than for use in the pod. Varieties such as "Dwarf Horticultural" and "French Horticultural" are examples of good shell beans. They mature in 65 to 70 days and have a bush habit.

There are both pole and bush type lima beans, which are sometimes called "butterbeans." Several types of pole lima beans exist. In general, the pole types take longer for the pods to mature than do bush types. Lima beans often drop their blossoms during excessively hot or rainy weather.

Edible soybeans are grown like bush snap beans. They require a longer growing season, usually 80 to 100 days. Pick them when the pods are nearly full-grown but before they begin to turn yellow. Shelling is easier if you drop the pods in a pot of boiling water for 15 to 20 minutes. The length of time they should be left in the boiling water depends on how tender you like them. After draining the water from the pods, sprinkle them with salt or dip in soy sauce. You can then squeeze the beans from the pods and eat them. Soybeans also can be grown for dry beans.

Plant Spacing—Plant bush snap beans in rows 24 to 30 inches apart. Plant seeds 2 to 3 inches apart in the row and 1 to 1 ½ inches deep in a well-prepared seedbed. It will usually take 1 pound of bush snap bean seed to plant 100 feet of row. Seed lima beans about 4 to 5 inches apart in the row. They do not produce well when they are crowded. Plant soybeans the same as bush snap beans. Plant pole beans 4 to 6 inches apart in rows 36 to 48 inches apart. You can have a continuous supply of beans by planting every two weeks until mid-August.

Diseases (Snap and Lima Beans)

Anthraxnose (fungus)—Pod spots are dark, sunken, circular or oval areas with brown borders and salmon-colored ooze in center; disease also occurs on leaves and stems. Do not save seed from diseased beans; use disease-free seed; rotate crops; plow under bean residue. Apply chlorothalonil at seven- to ten-day intervals starting at first sign of disease. Sulfur spray or dust can be used for disease control. Guard against phytotoxicity under certain weather conditions. Do not work wet plants.

Bacterial Blights (bacteria)—Brown or tan dead areas on the leaves as spots or blotches, often with a yellow border; pods may also show brick-red or brown sunken blotches. Use disease-free seed; avoid saving seed from one growing season to the next since bacteria can be carried to the seed; in severe cases, fixed copper fungicides applied at seven-day intervals at first sign of disease will assist in control.

Damping-Off and Seed Decay (fungi)—Failure of seeds to grow; death of young plants; poor stands. Buy seed treated with fungicides; plant seed in warm soil.

Root and Stem Rots (fungi)—Brown, decayed areas on lower stem and decayed roots, resulting in wilting, poor top growth, and death of plants. See "Damping-Off" above; rotate beans to another part of the garden from year to year so that root decay fungi won't build up in the soil.

Rust (fungus)—Small, rusty-brown spots (pustules) on leaves; mainly a late-season or fall garden problem. Use resistant varieties; chlorothalonil spray or sulfur dust will help prevent the disease; do not use chlorothalonil within seven days of harvest.

Bean Mosaic (virus: may include several different aphid-carried viruses)—Yellowing, crinkling, downward cupping of leaves; mosaic yellow and green patterns on leaves; dead areas along veins; on vine and runner types, dieback of the growing tip; disease carried to beans by aphids from clovers. Avoid planting beans near white or red clover or other legumes; plant bush beans or other resistant varieties; destroy legumes and other weeds near the garden; plant successive crops of beans; increased plant seeding density may also help.

Note: The treatments listed below were accurate when this publication went to press. Always consult the pesticide label before applying pesticides, as recommendations may change at any time.

Insect Treatments: 1. Malathion 50% EC, 2. Carbaryl 50% WP, (Sevin), 3. Pyrethrins, 4. Imidacloprid (Bayer FCVIC), 5. Cyfluthrin (Multi-Insect Killer), 6. Bifenthrin 0.3% + zeta-cypermethrin 0.075% EC (Ortho Bug-B-Gon Insect Killer for Lawns and Garden), 7. Bacillus thuringiensis var kurstaki, 8. Bacillus thuringiensis var san diego, 9. Carbaryl 5% B (Sevin), 10. Insecticidal soap, 11. Neem, 12. Horticultural Oil, 13. Bonide Eight Flower and Vegetable 0.115% granules, 14. Permethrin (Bonide Eight Insect Control Vegetable Fruit and Flower Concentrate), 15. Spinosad (Captan Jacks Dead Bug Brew), 16. Acetamiprid (Ortho Bug-B-Gone Systemic Insect Killer) 0.5%

Insects

See pages 25-28 for insect descriptions.

| Treatments | (see footnote below) |
|----------------------------|------------------------|
| Aphids | 1, 3, 4, 10, 11, 12 |
| Bean Leaf Beetles | 2, 11 |
| Corn Earworms | 2, 15 |
| Cutworms | 2, 9, 13 |
| Flea Beetles | 2, 11 |
| Grasshoppers | 1, 2, 9 |
| Japanese Beetles | 1, 2, 15 |
| Leafhoppers | 1, 2, 3, 4, 10, 11, 12 |
| Lygus Bugs | 1 |
| Mexican Bean Beetles | 2, 3, 11 |
| Mites | 1, 12 |
| Seed Maggots | 1 |
| Sowbugs | 9, 13 |
| Stink Bugs | 2 |
| Tarnished Plant Bugs | 2 |
| Whiteflies | 3, 4, 12 |

Beets

Beets are easy to grow and are rich in iron and vitamins A and C. The tops may be harvested as greens. Beets are sensitive to acid soil, so add lime before planting if a soil test so indicates.

Planting—Sow successively at about three- to four-week intervals from early spring to mid-August for a continuous supply of young, tender beets.

Plant seeds $\frac{1}{4}$ to $\frac{1}{2}$ inch deep in rows 18 inches apart or wider if you use a mechanical cultivator. Beet seeds are actually fruits containing several seeds. Thin the seedlings when well established to stand 2 to 3 inches apart in the row.

Problems—Boron deficiency in the soil can cause hard or corky black spots scattered throughout the root in light-colored zones. To alleviate this problem in subsequent years, sprinkle $\frac{1}{4}$ pound of borax/1000 square feet where beets are to be grown. Do not plant beans or soybeans in the same area for a year or two, since these vegetables are sensitive to boron toxicity.

Also, close planting or failure to thin can cause undersized roots to form.

Harvesting—Harvest for greens when the tops are large enough for cooking. For good quality roots, harvest when they are 1 $\frac{1}{2}$ inches or less in diameter. Beets will keep for several months if packed in moist sand and placed in a basement or garage. Do not let them freeze. Before storing, trim off all but $\frac{1}{4}$ inch of the tops.

Insects

See pages 25-28 for insect descriptions.

| Treatments | (see footnote below) |
|-----------------------------------|----------------------|
| Aphids | 1, 4, 11, 12 |
| Blister Beetles | 3 |
| Cutworms | 9 |
| Flea Beetles | 2, 4, 11, 15 |
| Harlequin Bugs | 2 |
| Imported Cabbageworms | 5, 7 |
| Leafhoppers | 2, 4, 11, 12 |
| Root Maggots & Seed Maggots | 1 |
| Sowbugs | 9 |
| Stink Bugs | 2 |
| Tarnished Plant Bugs | 2 |

Broccoli

There are different types of broccoli—annual green or, more rarely, purple broccoli; “romanesco,” which has yellowish green, conical groups of buds arranged in spirals; and sprouting broccoli, an overwintering annual or perennial, rarely grown in this country. Varieties differ in compactness and number of sprouting lateral heads. Broccoli is an excellent home garden vegetable, if the wormy insects can be controlled.

Planting—Buy transplants locally or produce your own and set out April 1 to 15 or by August 1. Transplants for a fall setting can be produced along with cabbage and cauliflower transplants, taking about four to six weeks from seeding to setting. Broccoli does much better as a fall crop. Set plants 14 to 18 inches apart in rows 30 inches apart. Use starter fertilizer for transplants.

Harvesting—The heads of broccoli are a mass of flower buds which must be harvested before the flowers open to show yellow. When mature, the central head measures 6 to 9 inches across. Lateral heads are smaller. When harvesting, cut 5 to 6 inches of the stem and accompanying leaves with the head. Use or freeze broccoli soon after harvesting.

Diseases

Black Rot (bacterium)—Yellow or tan-colored V-shaped areas on leaf edges; leaf veins and vascular ring in stem may be black; head may decay; young plants may be dwarfed or one-sided with yellow or brown shriveled leaves. Select tolerant varieties; use commercially grown, disease-free seed or transplants; rotate broccoli with other crops from year to year.

Damping-Off, Wirestem (fungus)—See “Damping-Off” discussion for beans; wirestem describes condition of seedling stem following stem decay. Use fungicide-treated seed or buy disease-free transplants. Plant shallowly, in warm soils. Avoid transplant shock.

Insects

See pages 25-28 for insect descriptions.

| Treatments | (see footnote below) |
|-----------------------------|---------------------------|
| Aphids | 1, 3, 4, 6, 11, 14, 16 |
| Cabbage Loopers | 6, 7, 14, 15, 16 |
| Cutworms | 6, 9, 13 |
| Diamondbacked Moths | 6, 7, 14, 15, 16 |
| Flea Beetles | 2, 3, 6, 11, 15 |
| Harlequin Bugs | 2, 3, 6, 16 |
| Imported Cabbageworms | 1, 2, 3, 6, 7, 14, 15, 16 |
| Sowbugs | 9, 13 |

Brussels Sprouts

The Brussels sprout is closely related to cabbage, cauliflower and broccoli. The plant's edible portions are the buds or small heads that grow in the axils of the leaves. The heads, about 1 inch in diameter, can be prepared like cabbage.

Planting—Brussels sprouts do best as an early spring crop or as a fall crop in a cool, moist climate. For an early spring crop, start the seed about eight weeks before the plants are to be transplanted to the garden. Well-grown transplants can be transplanted to the garden by March 15 in most areas of Kentucky, allowing for harvest in mid-June.

For a fall crop, sow seeds in open plant beds from May 15 to early June. Transplants will usually be ready in four to six weeks. Space plants 24 inches apart in the row. Cut off the top of plants in mid-September to firm up sprouts. Harvest after the first frost in October. Fall harvest is the most practical and rewarding.

Harvesting—Sprouts are produced earliest in the axils of the lower leaves of the plant. Harvest the sprouts when they are about 1 to 1 $\frac{1}{2}$ inch in diameter. The plant's lower leaves should be broken away and the sprouts twisted or cut off close to the stem with a sharp knife. Make successive harvests from the base upwards as the sprouts develop.

Diseases: see “Broccoli”

Insect Treatments: 1. Malathion 50% EC, 2. Carbaryl 50% WP, (Sevin), 3. Pyrethrins, 4. Imidacloprid (Bayer FCVIC), 5. Cyfluthrin (Multi-Insect Killer), 6. Bifenthrin 0.3% + zeta-cypermethrin 0.075% EC (Ortho Bug-B-Gon Insect Killer for Lawns and Garden), 7. Bacillus thuringiensis var kurstaki, 8. Bacillus thuringiensis var san diego, 9. Carbaryl 5% B (Sevin), 10. Insecticidal soap, 11. Neem, 12. Horticultural Oil, 13. Bonide Eight Flower and Vegetable 0.115% granules, 14. Permethrin (Bonide Eight Insect Control Vegetable Fruit and Flower Concentrate), 15. Spinosad (Captan Jacks Dead Bug Brew), 16. Acetamiprid (Ortho Bug-B-Gone Systemic Insect Killer) 0.5%

Insects

See pages 25-28 for insect descriptions.

| Treatments | (see footnote below) |
|---------------------------------|----------------------------|
| Aphids | 1, 3, 4, 6, 10, 11, 14, 16 |
| Cabbage Loopers..... | 1, 3, 6, 7, 14, 15, 16 |
| Cross-Striped Cabbageworms..... | 1, 3, 6, 7, 14, 15, 16 |
| Cutworms..... | 6, 9, 13 |
| Diamondbacked Moths..... | 1, 3, 6, 7, 14, 15, 16 |
| Flea Beetles | 2, 3, 6, 11, 15 |
| Harlequin Bugs | 2, 3, 6, 16 |
| Imported Cabbageworms.. | 1, 2, 3, 6, 7, 14, 15, 16 |
| Sowbugs..... | 9, 13 |

Cabbage

Cabbage grows in cool temperatures but is well-adapted for home gardens from March to December. It will withstand temperatures down to 20°F.

Cabbage heads differ in sizes, hardness, shape, color and leaf type. Cabbage can be used fresh or made into sauerkraut. Red cabbage can be pickled and adds color to slaw, but it is not adapted to cooking or for sauerkraut because it releases its red color to the juices. Generally, late cabbage is made into sauerkraut.

Planting—Buy locally grown transplants or start your own in growing structures four to six weeks before the planting date. A few seeds can be sown in the cold frame or garden every month up to July 15 to have cabbage plants to set at intervals during the season.

Plants take about three weeks from seeding to setting during the summer months. Plant only the earliest-maturing varieties after July 5.

Plant spacing affects head size; close spacing (9 to 12 inches apart in the row) produces small heads. The average spacing is 14 to 16 inches apart in rows spaced 30 inches apart. Varieties for sauerkraut are planted at the wider spacing.

Harvesting and Storage—Harvest cabbage when it reaches adequate size, depending on variety and growing conditions. Firm heads are preferred to soft heads, especially for storage. Heads can be left on the plant in the garden for about two weeks in the summer but longer in the fall after they are ready to harvest. Cabbage can be stored in the refrigerator for a month or two.

Long-term Storage—Harvest late fall or winter cabbage once the weather is cool by pulling up the plant with the root still attached. Discard the loose outer leaves and check for possible insect problems. Cabbage has a strong odor which may contaminate other vegetables. Hang plants by roots or wrap them in several sheets of newspaper tied with string. See “Storing Vegetables” on page 29.

Diseases: see “Broccoli”

Insects

See pages 25-28 for insect descriptions.

| Treatments | (see footnote below) |
|--------------------------|----------------------------|
| Aphids | 1, 3, 4, 6, 10, 11, 14, 16 |
| Cabbage Loopers..... | 1, 3, 6, 7, 14, 15, 16 |
| Cutworms..... | 6, 9, 13 |
| Diamondbacked Moths..... | 1, 6, 7, 14, 15, 16 |
| Flea Beetles | 3, 6, 11, 15 |
| Harlequin Bugs | 2, 3, 6, 16 |
| Imported Cabbageworms.. | 1, 2, 3, 6, 7, 14, 15, 16 |
| Root Maggots..... | 1 |
| Sowbugs..... | 9, 13 |

Carrots

Carrots are rich in vitamin A, thiamine and riboflavin. They may be cooked or eaten raw. Varieties with extremely long roots are not recommended for home gardens.

Planting—You can plant carrots from March 15 until the first of July. Sowing at three-week intervals will assure a continuous supply.

Plant seed ¼ inch deep in rows 18 inches or more apart. Since carrot seed is slow to germinate, radish seed is often mixed with it. The radishes will mark the row and break the soil crust, making it easier for the carrots to emerge. Thin carrots to 2 to 3 inches between plants after the seedlings are 1 to 2 inches tall.

Harvesting and Storage—Carrots may be harvested when they reach the desired size. Harvest fall-planted carrots before freezing weather. Wash the roots, trim tops to ½ inch and store in perforated plastic bags in the refrigerator, a cold, moist cellar or pit. Carrots will keep from two to four months. Do not store carrots in the same room as apples. Apples give off ethylene, which causes carrots to become bitter.

Insects

See pages 25-28 for insect descriptions.

| Treatments | (see footnote below) |
|----------------------------------|----------------------|
| Aphids | 3, 10, 11 |
| Cutworms..... | 5 |
| Flea Beetles | 2, 4, 5, 11, 15 |
| Root Maggots & Seed Maggots..... | 4 |
| Sowbugs..... | 9 |

Cauliflower

To develop the white center head, or curd, cauliflower plants probably require more exact growing conditions than any other vegetable crop. Cauliflower plants need a cool, humid climate.

Varieties differ in plant size, curd size, color (white, orange, purple), and days to maturity, ranging from 50 to 100 days.

Planting—Buy good quality transplants or start your own about four to six weeks before transplanting. Set plants 16 inches apart in rows 2½ feet apart March 10 to 25 for the spring crop and July 15 for the fall crop. Any interruption in growth (cold, heat, drought) can cause stunting and premature heading or “buttoning.” Cauliflower does much better as a fall crop.

Blanching—Exposing the young curd to sunlight discolors the curd and produces off flavors. Gather the long leaves over the small, white curd and tie them together or band them over the heads. This must be done as soon as the curd begins to show.

Harvesting—Curds will mature one or two weeks after tying, reaching about 6 to 9 inches in diameter. Heads will turn from clear white at peak of maturity to yellowish-brown when overly mature. Cool immediately after harvest and keep refrigerated. If storage for several weeks is required, leave a portion of the stalk and leaves to protect the delicate curd.

Diseases: see “Broccoli”

Insects

See pages 25-28 for insect descriptions.

| Treatments | (see footnote below) |
|---------------------------------|----------------------------|
| Aphids | 1, 3, 4, 6, 10, 11, 14, 16 |
| Cabbage Loopers..... | 1, 3, 6, 7, 14, 15, 16 |
| Cross-Striped Cabbageworms..... | 1, 3, 6, 7, 10, 14, 15, 16 |
| Cutworms..... | 6, 9, 13 |
| Diamondbacked Moths..... | 1, 3, 6, 7, 14, 15, 16 |
| Flea Beetles | 2, 3, 5, 6, 11, 15 |
| Harlequin Bugs | 2, 3, 6, 16 |
| Imported Cabbageworms.. | 1, 2, 3, 6, 7, 14, 15, 16 |
| Sowbugs..... | 9, 13 |

Insect Treatments: **1.** Malathion 50% EC, **2.** Carbaryl 50% WP, (Sevin), **3.** Pyrethrins, **4.** Imidacloprid (Bayer FCVIC), **5.** Cyfluthrin (Multi-Insect Killer), **6.** Bifenthrin 0.3% + zeta-cypermethrin 0.075% EC (Ortho Bug-B-Gon Insect Killer for Lawns and Garden), **7.** Bacillus thuringiensis var kurstaki, **8.** Bacillus thuringiensis var san diego, **9.** Carbaryl 5% B (Sevin), **10.** Insecticidal soap, **11.** Neem, **12.** Horticultural Oil, **13.** Bonide Eight Flower and Vegetable 0.115% granules, **14.** Permethrin (Bonide Eight Insect Control Vegetable Fruit and Flower Concentrate), **15.** Spinosad (Captan Jacks Dead Bug Brew), **16.** Acetamiprid (Ortho Bug-B-Gone Systemic Insect Killer) 0.5%

Chinese Cabbage

Chinese cabbage is one of the oldest vegetable crops, but it is seldom grown by Kentuckians. It is more closely related to mustard than to cabbage and is sometimes called Crispy Choy, Chihili, Michili and Wong Bok. The leaves are folded together into a conical head more or less open at the top. It is eaten raw or stir-fried.

Planting—Chinese cabbage can be more successfully grown as a fall rather than a spring crop. Plant seeds in 24-inch or wider rows in late July. Irrigation and mulch will aid germination and growth. Plants should be thinned to 12 to 15 inches in the row. Fertilize when half grown.

Harvesting—Harvest heads after the first moderate frost in the fall. Store Chinese cabbage in perforated plastic bags in the refrigerator, cellar or outdoor pit for up to two months.

Collards

Collards are a member of the cabbage family used as greens. They are highly nutritious and rather easy to grow.

Planting—Sow seed in mid-March or start plants indoors three weeks before outdoor planting time. Additional plantings can be made until mid-August. Plants should be set or thinned to 2 to 4 inches apart within the row. Rows should be 24 inches or wider if you use mechanical cultivators.

Harvesting—Harvest when the leaves reach a suitable size. The entire plant or the lower, larger leaves may be picked. If the lower leaves are harvested, upper leaves will develop for later use. Collards do not store well, but may be kept in plastic bags in the refrigerator for up to 14 days. The surplus can be frozen.

Diseases: see "Broccoli"

Insects

See pages 25-28 for insect descriptions.

| Treatments | (see footnote below) |
|----------------------------------|----------------------|
| Aphids | 1, 3, 10, 11, 16 |
| Cabbage Loopers..... | 1, 3, 7, 16 |
| Corn Earworms | 1, 2, 7, 16 |
| Cross-Striped Cabbageworms | 1, 7, 16 |
| Cutworms..... | 9 |
| Diamondbacked Moths..... | 1, 3, 7, 16 |
| Flea Beetles | 2, 11 |
| Harlequin Bugs | 1, 2, 16 |
| Imported Cabbageworms..... | 1, 2, 3, 7, 16 |
| Leafhoppers..... | 2, 4, 10, 11, 16 |
| Sowbugs..... | 9 |

Cucumber

Cucumber is a warm-season vegetable. Varieties differ in fruit types and uses; both the slicer, or fresh salad type, and the pickle type are available. The pickle type can also be used fresh. Varieties differ in flowering habit and amount of fruit set. The newer gynocious or all-female-flower hybrids are well adapted to home gardens and produce high yields. Cucumbers are multiple-harvest plants, providing fruits for four to eight weeks. A second planting in mid-to late June will provide quality fruit for late summer-early fall harvesting. Only a few plants are needed to provide an adequate supply.

Planting—Cucumber vines ramble and spread from row to row. Training on a trellis or fence along the edge of the garden will correct this and also lift fruit off soil. If trellised, plant four to five seeds/foot in rows spaced 30 inches apart. Untrellised rows may need to be spaced 4 feet apart. When plants are 4 to 5 inches high, thin them to stand 2 to 3 feet apart in the row. Cucumber plants are shallow rooted and require ample moisture at all growth stages.

Pollination—For the flower to develop into a fruit, bees must carry pollen from male flowers on the same plant or different plants to the female flower, the one with the tiny "pickle" at the base. Poor cucumber set is common during rainy weather when bees are inactive. Spray insecticides late in the day to avoid harming the bee population.

Harvesting—Fruits may be used when 1 ½ to 2 inches long up to any size before they begin to turn yellow. The length of this period is approximately 15 days for any one fruit. The harvesting period for all fruits extends for about six to eight weeks be-

fore plants begin to grow old. It is important to remove fruits before they turn yellow so plants continue to produce. If fruits are picked early, small plants can bear 35 to 50 cucumbers, but if fruits are picked at a large size, only five to 12 cucumbers will form on each plant. Old cucumbers prevent plant food from going into the production of new fruit.

Diseases

Anthraxnose, Leaf Spots (fungi)—Sunken circular or irregular spots with dark margins and salmon pink centers on fruits and stems; leaves with brown spots ¼-½ inch across; spots may join together and leaves shrivel and die; other leaf spots vary in size and shape of yellow or dead areas on leaves. Spray with chlorothalonil or mancozeb. Start at first sign of disease and continue as needed. Plant disease-free seed.

Bacterial Wilt (bacterium)—Wilting and drying of vines; bacterial ooze can sometimes be drawn out into fine strands from cut ends of stems. Use insecticides or other means to control striped and spotted cucumber beetles, which transmit the disease-causing bacteria. Use wilt-resistant cucumbers. Use a very thin floating row cover over transplants, sealed at the edges until flowering, as a barrier to cucumber beetles.

Fruit Rot (fungus)—Soft, mushy decay at blossom end of squash fruit; gray, moldy growth resembling a pin-cushion on rotted fruit. See Cucumber "Anthraxnose;" spray as young fruits develop.

Mosaic (virus)(may include several different aphid-carried viruses)—Mosaic and malformed leaves. Discolored, lumpy, malformed fruits. Use resistant varieties when available. Destroy weeds near the garden. Plant crops early or raise transplants in cold frame or greenhouse and set out as weather allows.

Powdery mildew (fungus)—White, powdery growth on leaves, yellowing and blighting of foliage. Use resistant varieties when available. Spray chlorothalonil, copper fungicides, sulfur spray or dust, horticultural or neem oils at first signs of disease and at weekly intervals. Guard against copper or sulfur phytotoxicity under certain weather conditions.

Insect Treatments: 1. Malathion 50% EC, 2. Carbaryl 50% WP, (Sevin), 3. Pyrethrins, 4. Imidacloprid (Bayer FCVIC), 5. Cyfluthrin (Multi-Insect Killer), 6. Bifenthrin 0.3% + zeta-cypermethrin 0.075% EC (Ortho Bug-B-Gon Insect Killer for Lawns and Garden), 7. Bacillus thuringiensis var kurstaki, 8. Bacillus thuringiensis var san diego, 9. Carbaryl 5% B (Sevin), 10. Insecticidal soap, 11. Neem, 12. Horticultural Oil, 13. Bonide Eight Flower and Vegetable 0.115% granules, 14. Permethrin (Bonide Eight Insect Control Vegetable Fruit and Flower Concentrate), 15. Spinosad (Captan Jacks Dead Bug Brew), 16. Acetamiprid (Ortho Bug-B-Gone Systemic Insect Killer) 0.5%

Seed Rot and Damping-Off (fungi)—Stand failure due to seed rot or seedling death. Plant seed in warm soils or raised beds. Use commercially treated seed.

Insects

See pages 25-28 for insect descriptions.

| Treatments | (see footnote below) |
|-----------------------|----------------------|
| Aphids | 1, 4, 6, 10, 11 |
| Cucumber Beetles..... | 1, 2, 4, 6, 14 |
| Cutworms..... | 6, 9, 13 |
| Leafhoppers..... | 2, 4, 6, 10, 11, 14 |
| Mites | 1, 10 |
| Sowbugs..... | 9, 13 |

Eggplant

Eggplant is a subtropical vegetable, very susceptible to cold soils and frost. Hybrid varieties are popular.

Planting—Buy transplants locally or grow your own in pots in growing structures. Transplants require about eight to ten weeks to develop when grown from seed. Set plants after late frost, about May 15. Maintain as much of the root system as possible at setting and fertilize with a liquid starter solution. Eggplant is more susceptible to cold injury than tomato. Fruit should be available 50 to 80 days after transplanting.

Harvesting—Fruits are edible from the time they are one-third grown until they are ripe and remain edible after achieving full color. Remove mature fruits so new ones can develop.

Cut fruits from the plant so that the branches will not be broken, and handle the easily bruised fruits carefully. Store them in a refrigerator.

Diseases

The only serious disease of eggplant that we see in Kentucky is Verticillium wilt. See "Tomatoes."

Insects

See pages 25-28 for insect descriptions.

| Treatments | (see footnote below) |
|------------------------------|------------------------|
| Aphids | 1, 3, 4, 6, 10, 11, 16 |
| Colorado Potato Beetles..... | 4, 8, 6, 11, 14 |
| Corn Earworms | 2, 6, 16 |
| Cutworms..... | 6, 9, 13 |
| Flea Beetles | 2, 3, 4, 6, 11 |
| Grasshoppers..... | 2, 6, 9 |
| Hornworms..... | 2, 6 |
| Leafhoppers..... | 2, 4, 6, 10, 11, 16 |
| Mites | 1 |
| Sowbugs..... | 9, 13 |
| Stink Bugs..... | 2, 6, 16 |

Insect Treatments: **1.** Malathion 50% EC, **2.** Carbaryl 50% WP, (Sevin), **3.** Pyrethrins, **4.** Imidacloprid (Bayer FCVIC), **5.** Cyfluthrin (Multi-Insect Killer), **6.** Bifenthrin 0.3% + zeta-cypermethrin 0.075% EC (Ortho Bug-B-Gon Insect Killer for Lawns and Garden), **7.** Bacillus thuringiensis var kurstaki, **8.** Bacillus thuringiensis var san diego, **9.** Carbaryl 5% B (Sevin), **10.** Insecticidal soap, **11.** Neem, **12.** Horticultural Oil, **13.** Bonide Eight Flower and Vegetable 0.115% granules, **14.** Permethrin (Bonide Eight Insect Control Vegetable Fruit and Flower Concentrate), **15.** Spinosad (Captan Jacks Dead Bug Brew), **16.** Acetamiprid (Ortho Bug-B-Gone Systemic Insect Killer) 0.5%

Garlic

There is only one species of true garlic. *Allium sativum*, an herbaceous biennial which belongs to the lily family. It is usually divided into two subspecies *ophioscordon* (hardneck or top set garlic) and *sativum* (softneck garlic). Hardneck garlic produces flower stalks called scapes and bulbils at the top of the stalk. Soft-neck garlic usually does not produce bulbils but produces larger bulbs with more cloves per bulb. The cloves which make up the mature garlic bulb are used for propagation. Propagation from bulbils is more difficult and requires two years to produce mature bulbs. Hardneck garlic cultivars usually do better in Kentucky and produce larger cloves that are easier to peel.

Planting—Planting and culture of garlic differ little from onions, but many gardeners believe garlic is more exacting in its requirements. No one cultivar or cultural practice is best suited for every situation. An open, sunny location, with a fertile well drained soil that is high in organic matter is desirable. Fertilizer is usual applied beginning in the spring as side-dressings every two weeks until bulbils begin to form. Garlic is day length sensitive and begins to bulb around the summer solstice. In Kentucky, it is best to plant garlic in October and early November. Plant individual cloves root end down and cover with two to three inches of well-drained soil. Allow six inches between sets. Mulch helps provide winter protection and conserves moisture during the summer. On hardneck garlic remove any flowering stalk that forms to increase bulb size. During the growing season garlic needs 1 in. of water/week. Stop watering about 2 weeks before harvest.

Harvesting—Many gardeners enjoy eating the green shoots and leaves of garlic plants. However, cutting them continuously inhibits bulb formation. By early June, flower stalks may appear and should be cut back and discarded so the plant's energies can be directed toward root and bulb formation. Some people eat the flower stalk. Bulbs begin to mature or ripen in mid-July and early August, and the leaves become yellow and the leaf tips turn brown. When the leaves have yellowed, lift the plants and dry the bulbs in a partly shaded storage area for about 2 weeks. After drying the

tops may be removed, braided or tied and then hung in a cool, well-ventilated spot. Dampness invites rotting. Properly dried garlic should last for 6-7 months at 32°F and 70% RH.

Kale

Kale is related to cabbage, collards, cauliflower, broccoli and Brussels sprouts. Kale is especially valuable nutritionally since it supplies important amounts of vitamin A, ascorbic acid and iron. Pound for pound, greens such as kale contain many times more vitamin A than snap beans, sweet corn or green peppers. Varieties are widely diverse, being tall or short, erect or flattened.

Planting—Seeds may be sown in the spring or in late summer where the plants are to stand, or they may be sown in seedbeds in the greenhouse or hotbed and transplanted to the garden. Plant a spring crop as early as the soil can be prepared.

Space plants 8 to 12 inches apart; rows should be 24 to 30 inches apart. Tall-growing types need the wider spacing.

Plant seed for the fall crop in late July and August.

Diseases: see "Broccoli"

Insects

See pages 25-28 for insect descriptions.

| Treatments | (see footnote below) |
|----------------------|----------------------|
| Aphids | 1, 4, 11, 16 |
| Armyworms..... | 1, 16 |
| Cabbage Loopers..... | 7, 16 |
| Cutworms..... | 9 |
| Flea Beetles | 2, 11 |
| Harlequin Bugs | 2, 16 |

Leeks

The leek resembles the onion in adaptability and cultural requirements. Instead of a bulb, leeks produce a thick, fleshy cylinder like a large green onion. The flavor is milder than an onion's. They are used in soups, sauces and as a pot herb.

Planting—Sow seed in early spring in rows 20 inches or wider apart. Thin plants to 3 to 4 inches apart within the row. Soil should be hilled around leeks as they grow to blanch them once they have the diameter of a pencil.

Harvesting—Leeks are ready to use after they reach a suitable size. Under favor-

able conditions they grow to 1 ½ inches or more in diameter, with white parts 6 to 8 inches long. They may be dug in autumn and stored like celery.

Lettuce

Lettuce is an important cool-season vegetable crop for salads and one of the easiest to grow. It tolerates light frost, but intense sunlight and high summer temperatures cause seedstalk formation and bitter flavors, especially in bibb types. Slow-bolting or heat-resistant varieties are available.

There are four types of lettuce: crisphead, the most common fresh market type; butterhead or bibb, most commonly grown in forcing structures; romaine or cos, a very nutritious lettuce that forms an upright head; and leaf, the most common home garden lettuce. The color of the leaf varieties differ from shades of green to red.

Planting—Seeds of leaf varieties are generally sown in rows, 20 to 30 seeds/foot, with rows 8 to 12 inches apart. For early and late planting, cos and head types should be started as transplants and spaced 12 to 18 inches apart in rows 20 inches apart.

Plant lettuce on the shady side of tall-growing crops such as sweet corn, staked tomatoes and pole beans, or in other cool areas of the garden. Interplanting (planting between rows or plants of later-maturing crops like tomatoes, broccoli and Brussels sprouts) can be practiced, especially in the fall garden. Border planting along the edges of the garden or flower bed is excellent. Make succession plantings so that lettuce will be available from May through November. Lettuce, especially leaf and bibb, does well in hotbeds during the winter months and in cold frames in the spring and late fall.

Problems—“Tipburn” is a physiological problem where the tips or edges of the lettuce leaves turn brown during a dry, hot period that has followed moist weather. No disease organism is associated, so chemical sprays will not correct the problem. Plants grown in shady areas are less affected than those grown in full sun and dry areas.

Harvesting—You can pick leaf lettuce as soon as the plants reach a suitable size. The older, outer leaves contain high levels of calcium and can be used first. Also, thinning the rows prevents crowding, so you

may wish to harvest every other plant or the very largest plants first.

Bibb lettuce is mature when leaves begin to cup inward to form a loose head. Cos or romaine is ready to use when leaves have elongated and overlapped to form a fairly tight head about 4 inches wide at the base and 6 to 8 inches tall. Crisphead is mature when leaves overlap to form a head similar to that available in the stores.

Crisphead lettuce will store about two weeks in the crisper drawer of the refrigerator before russetting begins. Leaf and bibb will store as long as four weeks if the leaves are dry when bagged. If lettuce is to be stored, harvest when dry. Do not wash; place in a plastic bag, and store in the crisper drawer. Wash before use.

Diseases

Damping-off—Use fungicide-treated seed and plant into well-drained soils.

Bottom rot—Cultural practices, warmed soils, and crop rotation are important tools to manage this disease. Do not plant lettuce after beans, and turn under grass and other crops early to ensure thorough rotting before planting. Avoid wet, poorly drained sites.

Insects

See pages 25-28 for insect descriptions.

| Treatments | (see footnote below) |
|----------------------------|-------------------------|
| Aphids | 1, 4, 6, 10, 11, 14, 16 |
| Corn Earworms | 2, 6, 14, 15, 16 |
| Cutworms..... | 6, 9, 13, 14 |
| Grasshoppers..... | 1, 2, 6, 9 |
| Imported Cabbageworms..... | 1, 6, 15, 16 |
| Leafhoppers..... | 1, 2, 4, 6, 11, 16 |
| Sowbugs..... | 9, 13 |

Muskmelons

Muskmelons, commonly called cantaloupes, are a warm-season crop. They require a relatively long growing season of 80 to 100 days from seed to marketable fruit. Some cultivars are not well suited to small gardens because of space required for growing the large vines. Cantaloupe grows quite well on black plastic mulch.

Planting and Transplanting—Cantaloupes can be produced from transplants, or they can be direct-seeded. Rows should be 5 feet apart with hills spaced 2 to 3 feet apart in the rows. Plant two or three seeds per hill. The seed should be placed ½ to ¾ inch deep after danger of frost is past.

To produce transplants, plant seed in individual containers three to four weeks before the plants are to be transplanted out-of-doors. Cantaloupes grown from transplants can be harvested as much as two weeks earlier than those grown directly from seed. Be careful not to injure the roots of seedlings when transplanting cantaloupes. Use starter fertilizer for transplants.

Cantaloupes should receive a nitrogen sidedressing when they begin to vine.

Pollination—Male and female flowers are separate on the same plant. Bees must carry pollen from the male flower to the female flower to ensure good fruit set and development. Delay insecticide applications until late in the day to prevent killing bees.

Harvesting and Handling—Melons should be harvested once they reach the full slip stage for best flavor. The term “full slip” indicates that fruit will pull away from the vine easily. Care should be taken when walking through the garden to avoid injury to plants. Plants can be trained during the early stages of development to grow in rows for easier harvesting. Growing on a trellis allows for closer spacing (3 feet between rows) than is possible when plants lie on the ground. Spraying to control cucumber beetles, aphids and fungal diseases is necessary.

Diseases: see “Cucumber”

Insects

See pages 25-28 for insect descriptions.

| Treatments | (see footnote below) |
|-----------------------|----------------------|
| Aphids | 1, 4, 6, 10, 11, 14 |
| Cucumber Beetles..... | 1, 4, 6, 14 |
| Cutworms..... | 6, 9, 13, 14 |
| Leafhoppers..... | 1, 4, 6, 10, 11, 14 |
| Stink bugs | 5, 6 |

Mustard Greens

Mustard greens are easy to grow, and they reach maturity quickly. They can be cooked or used in salads.

Planting—Mustard tends to bolt or go to seed quickly in hot weather. Plant in early March to late May as a spring crop and from late July to early September as a fall crop. Successive plantings during these periods will assure a continuous supply. Seed may be broadcast or sown in rows and thinned to 3 inches apart. Thinned plants

Insect Treatments: **1.** Malathion 50% EC, **2.** Carbaryl 50% WP, (Sevin), **3.** Pyrethrins, **4.** Imidacloprid (Bayer FCVIC), **5.** Cyfluthrin (Multi-Insect Killer), **6.** Bifenthrin 0.3% + zeta-cypermethrin 0.075% EC (Ortho Bug-B-Gon Insect Killer for Lawns and Garden), **7.** Bacillus thuringiensis var kurstaki, **8.** Bacillus thuringiensis var san diego, **9.** Carbaryl 5% B (Sevin), **10.** Insecticidal soap, **11.** Neem, **12.** Horticultural Oil, **13.** Bonide Eight Flower and Vegetable 0.115% granules, **14.** Permethrin (Bonide Eight Insect Control Vegetable Fruit and Flower Concentrate), **15.** Spinosad (Captan Jacks Dead Bug Brew), **16.** Acetamiprid (Ortho Bug-B-Gone Systemic Insect Killer) 0.5%

may be cooked or eaten fresh. Plant seeds ¼ inch deep in rows 18 inches or farther apart. Remove plants which bolt.

Harvesting—Pick leaves as they become large enough to use. Greens mature quickly and do not store well, so several plantings may be desired. Mustard greens can be stored in plastic bags in the refrigerator for one to two weeks.

Okra

Okra is a warm-season crop. Varieties differ in plant size, pod type and color, and number of spines. Dwarf plants without spines and with smooth, green pods are best for home gardens. Fruits are used as flavoring in soups, such as gumbo, and they can be fried.

Planting—Soak seeds for 6 hours in warm water and sow about 12 inches apart in rows 30 inches apart.

Harvesting—Cut pods off when they are about 2 to 4 inches long. Once harvesting starts, continue to harvest every two to three days until frost. Store pods in plastic bags in the refrigerator for a week, or blanch and freeze them for later use. They pickle nicely also.

Insects

See pages 25-28 for insect descriptions.

| | |
|------------------------|----------------------|
| Treatments | (see footnote below) |
| Aphids | 1, 4, 11 |
| Bliester Beetles | 2 |
| Japanese Beetles | 1, 2 |

Onions

The two main types of onions are American (pungent) and foreign (mild). Each type has three distinct colors: yellow, white and red. In general, the American onion produces bulbs of smaller size, denser texture, stronger flavor and better keeping quality.

For green or bunching onions, use sets, seeds or transplants for spring planting. For fall planting, use Egyptian or perennial tree and the yellow multiplier or potato onion sets.

Onions that keep well in storage are globe types. Globe varieties are yellow, red and white. They should be grown from seeds.

Planting—Spring-planted sets are popular and may be placed 1 to 2 inches apart and 1 to 2 inches deep in the row. Thin them to 4-inch spacing by pulling and using the thinned plants as green onions. Rows should be 12 to 18 inches apart. Avoid large sets in spring plantings. Sets more than ⅞ inch in diameter are likely to produce seed stalks. Divide the onion sets into two sizes before planting. Large sets (bigger than a dime) are best used for green onions. The smaller sets produce the best bulbs for large, dry onions. Early planting and/or exposure to cold temperatures may also cause seed stalk development.

Sets of Egyptian tree or multiplier onions should be harvested in late October or early November. Fall-planted sets should be spaced 4 inches apart in rows 1 to 2 feet apart. (Distance between rows is determined by available space and cultivating equipment). Onions are shallow-rooted and compete poorly with weeds and grasses.

Harvesting and Storage—Pull green onions whenever the tops are 6 inches high. Bulb onions should be harvested when about two-thirds of the tops have fallen over. Careful handling to avoid bruising will pay big dividends in controlling storage rots. Onions may be pulled and left to dry. Place them so bulbs are partly covered with tops to avoid sunscald. If space is available, onions may be placed inside a building for curing. Tops may be left on or cut off. When curing inside, spread onions out. Onions may be hung up to dry in small bunches. Before storing, remove most of the top from each onion, leaving about ¾ inch. Put onions in mesh bags, ventilated wooden crates or a well-ventilated storage space after they have thoroughly cured. Curing usually takes three to four weeks. Immature, soft and thick-necked bulbs should not be stored with other onions. The essentials for successful storage are thorough ventilation, uniform temperatures of 35° to 40°F, dry atmosphere, and protection against actual freezing.

Long-term Storage—The best varieties for storage are grown from seeds rather than sets. Harvest them when tops have turned brown and died or in late fall before the ground freezes. Remove bruised onions or onions with thick “bull necks” and use

them first because they will not store well. Onions must be allowed to dry for several weeks before storage. Spread them no more than two layers deep on newspaper. Put them out of the direct sun in a well-ventilated area until the skins are papery and the roots shrivelled.

When they are dry, hang them in braids or put them in mesh bags. Braid them soon after digging while the stalks are still pliable. Store in a well-ventilated, cool, dry, dark area. See “Storing Vegetables” on page 29.

Insects

See pages 25-28 for insect descriptions.

| | |
|-----------------------------------|----------------------|
| Treatments | (see footnote below) |
| Root Maggots & Seed Maggots | 1 |
| Thrips | 1, 6, 11 |

Parsnips

Parsnips are a hardy, full-season, winter vegetable. Their high food value and eating quality are greatly improved by storing at near-freezing temperatures, which increases the sugar content. This crop stores well and is therefore available for eating from late fall to late winter.

Parsnips require a long growing time, from 100 to 160 days. One 20- to 25-foot row of parsnips is usually ample for a family's needs.

Planting—Parsnip seed retains its vitality for only about one year, so never plant old seed. The seed is slow to germinate, and it may be difficult to get a good stand if soils are heavy and moisture is low. Hasten germination and emergence by (1) sowing a few radish seeds along with the parsnip—they will help break soil crust and allow parsnip seedlings to emerge and also provide a double crop; (2) covering the seed with leaf mold, ashes or sandy soil; (3) firming the covering material over the row and watering with a watering can or spray nozzle.

The seed should be planted ½ to ¾ inch deep from June 15 to July 1 in rows spaced 18 inches apart, with seeds 2 to 3 inches apart in the row. When plants are grown too far apart the roots become large and the edible portion has a woody, fibrous texture.

Harvesting and Storage—Parsnip roots may be dug in late fall, topped and stored

Insect Treatments: 1. Malathion 50% EC, 2. Carbaryl 50% WP, (Sevin), 3. Pyrethrins, 4. Imidacloprid (Bayer FCVIC), 5. Cyfluthrin (Multi-Insect Killer), 6. Bifenthrin 0.3% + zeta-cypermethrin 0.075% EC (Ortho Bug-B-Gon Insect Killer for Lawns and Garden), 7. Bacillus thuringiensis var kurstaki, 8. Bacillus thuringiensis var san diego, 9. Carbaryl 5% B (Sevin), 10. Insecticidal soap, 11. Neem, 12. Horticultural Oil, 13. Bonide Eight Flower and Vegetable 0.115% granules, 14. Permethrin (Bonide Eight Insect Control Vegetable Fruit and Flower Concentrate), 15. Spinosad (Captan Jacks Dead Bug Brew), 16. Acetamiprid (Ortho Bug-B-Gone Systemic Insect Killer) 0.5%

at 32° to 40°F in a root cellar or in an outdoor pit. They may be left in the ground through winter. Parsnips will tolerate alternate freezing and thawing in soil but will be damaged if frozen after harvest. A heavy mulch over the parsnips will delay freezing of the soil; mulch can be pulled aside, and parsnips can be harvested late into the winter. See “Storing Vegetables” on page 29.

Insects

See pages 25-28 for insect descriptions.

| | |
|-------------------|-----------------------------|
| Treatments | <i>(see footnote below)</i> |
| Cutworms..... | 9 |
| Sowbugs..... | 9 |

Peas

Peas are a cool-season legume crop and should only be planted in early spring or late summer.

Podded peas (snow or snap peas) are usually eaten cooked or raw, pod and all. They possess the tenderness and pod qualities of snap beans and the flavor and sweetness of fresh English peas. Seeds may be shelled and eaten like regular peas if pods develop too fast.

Planting—Plant peas in spring as soon as soil is workable. Early planting normally produces larger yields than later plantings. They will tolerate light freezes. A few successive plantings can be made at one- to two-week intervals. A single planting of early-, midseason- and late-maturing varieties will also extend the supply. Plant a fall crop of snow or snap peas around the first week of August. These plants will require irrigation.

Sow about 15 seeds/foot of row and cover about 1 inch deep. Rows of dwarf varieties should be planted 2 ½ to 3 feet apart, and tall varieties 3 ½ to 4 feet apart. Tall varieties of peas will benefit from some support for the vines. Branches may be placed in the row, or seeds may be planted along a fence or string trellis.

Dwarf pea varieties seldom need support. Many gardeners plant twin rows of dwarf varieties 6 to 10 inches apart and allow them to support themselves. The peas may also be scattered about 4 inches apart in all directions in rows about 2 feet wide.

Harvesting—Harvest peas when pods have filled. For tender peas, harvest a bit

immature. Use peas as soon after harvest as possible. They will stay fresh longer if left in the pods until they are to be cooked. They will keep up to a week in plastic bags in the refrigerator. Some varieties are superior to others for freezing.

Insects

See pages 25-28 for insect descriptions.

| | |
|-------------------|-----------------------------|
| Treatments | <i>(see footnote below)</i> |
| Aphids..... | 1, 4, 11 |
| Cutworms..... | 9, 13 |
| Sowbugs..... | 9, 13 |

Peppers

A number of pepper types are available to the home gardener. These include bell or green, banana, pimento, cherry, cayenne or red or green chili peppers, serrano, yellow wax, habanero, and other hot types. All are grown similarly.

Planting—Begin transplants indoors eight to ten weeks before planting time. Set plants after all danger of frost has past. Direct seeding of peppers in the garden may be done, but transplants are generally more satisfactory and will provide heavier yields. Use a starter fertilizer when transplanting. Apply supplemental fertilizer cautiously and only after a good crop of peppers is set. Rows should be 30 to 36 inches apart or wider if mechanical cultivators are used. Set plants 14 to 18 inches apart within the row.

Harvesting—Harvest peppers when they are firm. If red fruits are desired, allow the green fruit to remain on the plant until the red color develops. Cut peppers from the plant to prevent injuring the plant and remaining fruit. Leaving a short piece of stem will allow the pepper to store longer. Store peppers in the refrigerator in plastic bags. They will keep two to three weeks. Gather remaining peppers before a hard frost.

Diseases

Bacterial Spot (bacterium)—Dark brown to tan irregular spots on leaves; leaves turn yellow and drop from the plant. Treat seed by washing for 40 minutes in a solution of household bleach (½ cup/pint of water); air dry promptly, then plant. Use disease-free transplants; spray with fixed copper at first sign of disease and thereafter as needed.

Fruit Soft Rot (bacterium)—Smelly, soft decay of fruit. Control fruit-feeding insects and bacterial leaf spot.

Insects

See pages 25-28 for insect descriptions.

| | |
|---------------------------|-----------------------------|
| Treatments | <i>(see footnote below)</i> |
| Aphids..... | 1, 4, 6, 11, 12, 16 |
| Cutworms..... | 5, 6, 9, 13 |
| European Corn Borers..... | 2, 5, 6, 14, 16 |
| Flea Beetles..... | 4, 5, 6, 11, 14 |
| Sowbugs..... | 9, 13 |
| Stink bugs..... | 5, 6, 16 |

Potatoes

In Kentucky, potatoes can be grown as an early crop for fresh use in early summer and as a late crop for table use in winter. White-skinned, red-skinned, and yellow-skinned varieties are excellent for planting. Choose an early-maturing variety and a medium- to late-maturing variety. The planting time for early potatoes is from March 1 to April 10; for the late crop, June 15. The late planting will generally give a lower yield than the spring planting.

Recently turned-under sod may have populations of grub worms and/or wireworms which can cause serious damage to developing potato tubers unless soil insecticides are used. The yield of potato tubers is influenced by season, variety, moisture availability and the amount of nutrient elements available to the plant. Highest yields are obtained in years with cool springs and adequate moisture throughout the season.

Fertilizers—Potatoes require large amounts of fertilizer. A soil pH of 6.0 to 6.5 is considered most desirable; however, scab disease will usually be less when pH is between 5.0 and 5.2.

In addition to the base application of fertilizer worked into the garden soil, add about ¼ pound of 10-20-10 for each 75 feet of row. Work this into the bottom of the furrow and mix with soil before putting down the seed piece.

Seed Selection and Planting—Purchase certified seed stock. The “certified” means that stock has been inspected for diseases which cause low yields. Seed potatoes should be firm and unsprouted. Wilted and sprouted potatoes usually have lost vigor from being too warm in storage.

Cut seed pieces to about 2 ounces for planting. Each seed piece should have two

Insect Treatments: **1.** Malathion 50% EC, **2.** Carbaryl 50% WP, (Sevin), **3.** Pyrethrins, **4.** Imidacloprid (Bayer FCVIC), **5.** Cyfluthrin (Multi-Insect Killer), **6.** Bifenthrin 0.3% + zeta-cypermethrin 0.075% EC (Ortho Bug-B-Gon Insect Killer for Lawns and Garden), **7.** Bacillus thuringiensis var kurstaki, **8.** Bacillus thuringiensis var san diego, **9.** Carbaryl 5% B (Sevin), **10.** Insecticidal soap, **11.** Neem, **12.** Horticultural Oil, **13.** Bonide Eight Flower and Vegetable 0.115% granules, **14.** Permethrin (Bonide Eight Insect Control Vegetable Fruit and Flower Concentrate), **15.** Spinosad (Captan Jacks Dead Bug Brew), **16.** Acetamiprid (Ortho Bug-B-Gone Systemic Insect Killer) 0.5%

to three eyes. Potatoes weighing about 6 ounces will cut into three pieces nicely. Potatoes planted in early March should be planted in furrows 3 to 5 inches deep, and the late crop should be planted 5 to 6 inches deep. Seed pieces should be spaced 10 to 12 inches apart, and furrows about 36 inches apart.

Cultivation—At planting, pull a ridge of soil over each row. Dragging across the ridges just before the sprouts break through helps eliminate any weeds and grasses and allows the sprouts to break through more easily. Later cultivation should be shallow and far enough from rows to make certain no roots are pruned.

When tops have made sufficient growth that cultivation must stop, a finishing cultivation, sometimes called “laying by,” is given. “Laying by” throws soil over the potatoes to help prevent exposure to the sun, which can cause greening and “scalding.”

Abiotic Problems—“Hollow heart,” a condition where large potatoes have a hollow center, is caused by the potato growing too rapidly or getting too large. Closer spacing of plants will cause tubers to grow slower and be smaller. High temperatures (above 95°F) may cause black discoloration inside potato tubers due to lack of oxygen during rapid respiration.

Knobby tubers are caused when the potato stops growing, due to drought, and then starts growing again when moisture is supplied.

Fine, black strands or necrosis inside the potato’s vascular tissue may be due to freeze damage in handling or storage or to heat damage in the garden or storage. Irrigation and mulching will help keep the soil cool.

Harvesting—The early crop of potatoes can be dug before the skins are mature and while they are still somewhat small. For mature potatoes, wait and harvest after vines have been dead for two weeks so skins of potatoes will have toughened. This method minimizes losses due to skinning. Potatoes should be quickly removed from the field or shaded during periods of bright sunlight and high temperature to avoid the danger of sunscald. Be careful to avoid bruising the tubers at all times. Dig late potato crop when first frost has nipped the vines.

Storage—With proper care, potatoes can be stored for four to six months. The most important factor is storage temperature, 40°F being ideal. Sprouting in storage is a serious problem at high temperatures. Other important factors include maintenance of high humidity (80% to 90%), proper ventilation, and having tubers which are free of disease when placed in storage. Clean your storage room thoroughly before storing potatoes.

Long-term Storage—Late maturing potatoes will store better than early ones. Harvest after the vines die completely and when the ground is damp but not wet. Remove the withered vines before digging. Dig carefully to avoid bruising and let tubers surface dry before storing. Potatoes need to be cured for ten to 14 days at 50° to 55°F in the dark with high relative humidity before storing. They will turn green and become bitter if exposed to light. If tubers in the garden are set shallow and are turning green, they should be hilled (covered with soil) for two to three weeks. Most will be normal when dug. Pack them unwashed in baskets, boxes or open mesh bags. Sprouting of potatoes indicates they were stored in too warm a place. Sweet-tasting potatoes indicate that they were stored in too cool a place. See “Storing Vegetables” on page 29.

Diseases: White or Irish Potatoes

Black Leg (bacterium) and other seedborne diseases (fungi, nematodes)—Stems decay and blacken at or below ground line; tops grow poorly, may turn yellow, wilt and die; soft rot on tubers in storage. Seed tubers decay; poor stands or low yields result. Plant only certified disease-free tubers; plant cut seed immediately or allow to cork over before planting; allow tubers to warm up several days before planting; do not plant cold potatoes in cold soil.

Early Blight (fungus)—See Tomato “Early Blight” for description and management suggestions. Maintain adequate nitrogen and potassium fertility to reduce early blight susceptibility.

Late Blight (fungus)—Nationally, the potential for late blight has increased greatly, but this disease is relatively rare in Kentucky. Dead areas on leaves, brown or dark purple color, variable in size with white or gray moldy growth on leaf undersides dur-

ing cool, moist weather; whole plant can become blighted; tuber infection causes discoloration under skin and decay in field or storage. Use varieties with partial resistance; plant disease-free tubers. Use chlorothalonil, copper fungicides, phosphorous acid, or mancozeb as needed.

Rhizoctonia “scurf” appears on mature tubers as small, black specks, known as “the dirt that can’t be washed off.” Using clean seed and rotation will help prevent occurrence of this disease.

Scab (bacterium)—Rough, scabby lesions on tubers. Plant resistant varieties; do not apply manure within 2 months of planting; maintain acid soil for potato culture and practice crop rotation.

Virus diseases such as mosaic and leaf roll can be carried in the seed piece and transmitted from one plant to another by insects. Use certified seed, which is relatively free of viruses. Good insect control will also help prevent infection.

Insects

See pages 25-28 for insect descriptions.

| Treatments | (see footnote below) |
|------------------------------|----------------------|
| Aphids | 10, 11 |
| Blister Beetles | 2 |
| Colorado Potato Beetles..... | 2, 8, 11, 14, 15 |
| Cutworms..... | 2, 9 |
| Leafhoppers..... | 1, 10, 11, 14 |
| Sowbugs..... | 9 |

Pumpkins

Pumpkins should only be grown if a great deal of space is available. Many people plant pumpkins among early corn. Pumpkins are one of the few vegetables which thrive under partial shade, and sweet corn will be harvested before they require a great deal of room. For extra large pumpkins, remove all but one or two fruits from a vine.

Planting—Plant pumpkins for Halloween around mid-June. If pumpkins are planted too early they may rot before Halloween. Seed pumpkins in hills spaced 8 to 12 feet apart in each direction. Do not plant until all danger of frost is past.

Harvesting—Harvest pumpkins whenever they are a deep, solid color and the rind has hardened but before they are injured by hard frost. When cutting pumpkins from the vine, leave a portion of the stem attached. Pumpkins keep best in a

Insect Treatments: 1. Malathion 50% EC, 2. Carbaryl 50% WP, (Sevin), 3. Pyrethrins, 4. Imidacloprid (Bayer FCVIC), 5. Cyfluthrin (Multi-Insect Killer), 6. Bifenthrin 0.3% + zeta-cypermethrin 0.075% EC (Ortho Bug-B-Gon Insect Killer for Lawns and Garden), 7. Bacillus thuringiensis var kurstaki, 8. Bacillus thuringiensis var san diego, 9. Carbaryl 5% B (Sevin), 10. Insecticidal soap, 11. Neem, 12. Horticultural Oil, 13. Bonide Eight Flower and Vegetable 0.115% granules, 14. Permethrin (Bonide Eight Insect Control Vegetable Fruit and Flower Concentrate), 15. Spinosad (Captan Jacks Dead Bug Brew), 16. Acetamiprid (Ortho Bug-B-Gone Systemic Insect Killer) 0.5%

well-ventilated place where the temperature is 55° to 60°F.

Long-term Storage—Winter squash and pumpkins must stay on the plants until fully mature. Fruit maturity can be roughly estimated by pressure from the thumbnail on the fruit skin. If the skin is hard and impervious to scratching, then it is mature.

Harvest before a hard frost with a sharp knife, leaving at least 1 inch of stem attached. Fruit picked without a stem will soon decay around the stem scar. Handle pumpkins and squash carefully to avoid bruising. All winter pumpkins and squashes should be cured in a warm, dry place for ten days at 75° to 85°F before storage at 50° to 55°F in a dry area. Examine the fruit every few weeks for mold and discard any contaminated produce. See “Storing Vegetables” on page 29.

Diseases: see “Cucumber”

Insects

See pages 25-28 for insect descriptions.

| | |
|-----------------------|-----------------------------|
| Treatments | <i>(see footnote below)</i> |
| Aphids | 1, 4, 6, 10, 11, 14, 16 |
| Cucumber Beetles..... | 1, 2, 4, 6, 14, 16 |
| Squash Bugs..... | 2, 6, 14, 16 |
| Stink bugs | 5, 6, 16 |

Radishes

Radishes are easy and quick to grow. Cool weather is essential for highest radish quality since they become “hot” and woody in hot weather. Small, round varieties mature more quickly than long types.

Planting—Sow seed ¼ inch deep in rows 12 inches or wider. Radishes should be thinned to allow 2 to 3 inches between plants. Make several small plantings at seven- to ten-day intervals since radishes are in prime condition for only a few days. Plant in early spring or as a fall crop around the first of August.

Harvesting—Harvest radishes when roots are ½ to 1 inch in diameter. Radishes remain in edible condition for only a short time before they become pithy and hot. Wash roots, trim both tap root and tops and store in plastic bags in refrigerator. They will keep up to a month.

Diseases

Damping off—Use fungicide-treated seed and plant into well-drained, warmed soils.

Insects

See pages 25-28 for insect descriptions.

| | |
|----------------------------------|-----------------------------|
| Treatments | <i>(see footnote below)</i> |
| Cutworms..... | 5, 9 |
| Flea beetles | 1, 2, 4, 5, 15 |
| Root Maggots & Seed Maggots..... | 1 |
| Sowbugs..... | 9 |

Rhubarb

Rhubarb is propagated by planting pieces of rhubarb crown. These pieces can be purchased commercially or obtained from old plants. If you have an old plant, cut through the crown between the buds, leaving as large a piece of storage root as possible with each large bud. Plant crown in early spring (March). If you must hold the crown for a week or longer before planting, store it in a cool, dark place.

Divide crowns and make new plantings when plants have borne for about four years, or whenever the production of numerous small stalks indicates that crowns are becoming crowded.

Propagation by seed is not recommended because rhubarb seedlings do not “come true to type” from parent plants.

Crown pieces are usually transplanted in rows 4 to 5 feet apart, with plants spaced along the row 3 feet apart. Crown pieces should be planted with 2 to 3 inches of soil above the pieces. Since this planting is intended to stay in place for more than one season, it should be at the edge of the garden or along a fence in a well-drained area.

Each year, soon after the ground is frozen, cover the rows with straw or similar mulch material. Rake it off the row in early spring so new growth can get started.

Harvesting—Rhubarb may be harvested for a short period during the second year and for full harvest (eight to ten weeks) during the third growing season and thereafter. Pull stalks from the base instead of cutting them.

Special Note—To promote and maintain vigorous growth, rhubarb should not be allowed to flower. Remove flower stalks as soon as they appear by cutting or pinching them off near the crown of the plant.

Diseases

Crown Rot (bacterium or fungus)—Brown, soft, decayed areas at base of leaf stalk; decay spreads to crown and other stalks;

leaves wilt and plant dies. Carefully remove and destroy decayed plants; spray crowns of nearby healthy plants with fixed copper fungicide; start a planting in a new location using disease-free plants on raised or well-drained beds.

Insects

Eliminate curly doc weeds that may serve as host for rhubarb curculio.

Southern Peas

The southern pea, a warm-season crop, is sometimes referred to as cow pea, crowder pea, field pea and black-eyed pea. It is not a true pea but a bean with high protein content that is commonly grown in the South. This crop should be included in every Kentucky home garden.

Planting—Sow seeds 2 to 3 inches apart in rows 30 inches apart.

Harvesting—Vegetable can be used fresh, canned, frozen or as dry shelled beans.

Both seeds and pods are eaten in the green, immature stage like snap beans, or they can be left to further mature the seed. Shell before pods turn yellow. For dry use, let pods turn brown or yellow and then shell.

Diseases and Insects: see “Beans”

Spinach

Spinach is a quick-maturing, cool-season crop of high nutritional value. It can be grown early in spring and from late fall into winter. Hot summer days cause it to bolt. Some varieties will mature as early as 20 to 40 days after sowing under favorable weather conditions. Spinach is well-adapted to winter production in cold frames.

Varieties differ in seed type (smooth or round vs. prickly seeded) and in leaf type (smooth vs. savoy-leaves). The round-seeded types are most popular.

Planting—Sow seeds around March 1 in rows spaced 12 to 18 inches apart. Start fall seeding between August 15 and September 1. Thin plants to stand 4 to 6 inches apart in rows. It is important to firm soil over the rows so there is good contact with seed for high germination. Spinach grows best with ample moisture and fertile, well-drained soil.

Insect Treatments: 1. Malathion 50% EC, 2. Carbaryl 50% WP, (Sevin), 3. Pyrethrins, 4. Imidacloprid (Bayer FCVIC), 5. Cyfluthrin (Multi-Insect Killer), 6. Bifenthrin 0.3% + zeta-cypermethrin 0.075% EC (Ortho Bug-B-Gon Insect Killer for Lawns and Garden), 7. Bacillus thuringiensis var kurstaki, 8. Bacillus thuringiensis var san diego, 9. Carbaryl 5% B (Sevin), 10. Insecticidal soap, 11. Neem, 12. Horticultural Oil, 13. Bonide Eight Flower and Vegetable 0.115% granules, 14. Permethrin (Bonide Eight Insect Control Vegetable Fruit and Flower Concentrate), 15. Spinosad (Captan Jacks Dead Bug Brew), 16. Acetamiprid (Ortho Bug-B-Gone Systemic Insect Killer) 0.5%

Harvesting—Cut whole plants at soil surface when they reach 4 to 6 inches in diameter. Making successive plantings is better than removing only outer leaves, allowing inner leaves to make additional growth. Use or place in refrigerator immediately after harvest.

Diseases

Damping-off may be biggest problem for home garden. Use fungicide-treated seed and plant into well-drained, warmed soils.

Insects

See pages 25-28 for insect descriptions.

| | |
|----------------------|-----------------------------|
| Treatments | <i>(see footnote below)</i> |
| Aphids | 1, 4, 11, 14, 16 |
| Armyworms..... | 2, 7, 9, 14, 15, 16 |
| Cabbage Loopers..... | 7, 14, 15, 16 |
| Cutworms..... | 9, 14 |
| Sowbugs..... | 9 |

Squash

Squash may be divided into two classes—summer and winter.

Summer squash are bush-type plants and are well suited for small gardens. Fruits are eaten in immature stages, when the rind can be easily penetrated by the thumbnail. Under favorable conditions, most summer varieties produce their first usable fruits seven to eight weeks after planting and continue to bear several weeks afterward.

Winter squash include varieties such as butternut, hubbard and acorn and require more room than summer types. Bush type winter squash such as ‘Table King’ and ‘Gold Nugget’ are available, so this vegetable could be part of smaller gardens. The division between winter squash and pumpkins is not absolute. Winter squash have flesh that is dark orange, sweeter, less fibrous, and higher in dry matter than pumpkins and summer squash. Winter squash have hard rinds and are well adapted for storage. Harvest for storage only when the rind is hard enough to resist denting by a thumbnail.

Planting—Seed summer squash in the garden after danger of frost is past, in hills 4 feet apart with two to three seeds/hill. Bush types of winter squash use the same spacing, but separate vining types by at least 6 to 8 feet between hills.

For extra early fruit, plant seeds in peat pots in greenhouses or hotbeds and trans-

plant them to the garden about three weeks later. Squashes are warm-season plants and do not do well until soil and air temperatures are above 60°F. Soil pH can be between 5.5 and 7.5.

Black plastic can be put on soil, and seed or transplants can be planted through the plastic. Seed should be covered 1 inch deep with soil.

Storage—Summer squash will store up to a week if kept in a perforated plastic bag in the refrigerator. Take care in harvesting not to bruise or injure fruits.

Harvest winter squash for storage when the rind is quite hard. Do not leave them exposed to frost, which reduces their keeping quality. Leave a portion of stems and handle carefully to avoid bruising. Keep in a well-ventilated place for several weeks and examine frequently for decay. Remaining sound fruit should be placed in a clean area with a temperature of around 55°F and with 60% relative humidity. Acorn squash do not store longer than a month or so. See “Storing Vegetables” on page 29.

Long-term Storage—see “Pumpkins”

Diseases: see “Cucumber”

Insects

See pages 25-28 for insect descriptions.

| | |
|-------------------------|-----------------------------|
| Treatments | <i>(see footnote below)</i> |
| Aphids | 1, 4, 6, 11, 12, 16 |
| Cucumber Beetles..... | 1, 2, 4, 5, 6, 14, 16 |
| Cutworms..... | 6, 9, 14 |
| Sowbugs..... | 9, 13 |
| Squash Bugs..... | 2, 6, 14, 16 |
| Squash Vine Borers..... | 5, 6, 16 |
| Stink bugs | 5, 6, 16 |

Sweet Corn

Sweet corn varieties differ a great deal in quality and time of maturity. Weather is also an important influence on the number of days required to reach maturity from seeding date. Maturation may be increased under high temperature conditions or delayed under cool ones.

To keep sugar content high in super-sweet cultivars and to avoid mixtures of white and yellow kernels, prevent cross pollination by providing a certain amount of isolation. When planting at different times, a minimum of 14 days difference in maturity dates of cultivars is required. For example, ‘Vision’ is a super-sweet cultivar with 75 days to maturity. It could be

planted at the same time as ‘Silver Queen,’ which is a standard cultivar and matures in 95 days.

An example of preventing a mix of yellow and white kernels would be the planting of ‘Silver Queen’ and ‘Golden Queen.’ If both these cultivars are desired in the same growing season and you do not want mixed kernels, stagger the planting of one of them by two weeks. No cross pollination should occur if planting times are scheduled accordingly.

Fertilization—An additional sidedressing of ammonium nitrate when corn is knee-high, using about ¼ pound per 25 feet of row, should adequately supplement the regular garden fertilization program.

Planting—Gardeners interested in having sweet corn early may plant just a few days before the average date of the last killing frost. The harvest period for sweet corn can be extended by planting early-, mid-season- and late-maturing varieties or by making successive plantings. Make successive plantings every two weeks throughout the season until July 15. Use only earliest maturing varieties for July plantings. The fall-maturing sweet corn will give high quality because of cool nights in September, but is also much more prone to worm damage.

For early-maturing varieties that produce small plants, plant at row spacings of 30 inches with plants 8 to 9 inches apart in the row. For medium to large plant varieties, use a 36-inch to 40-inch row spacing with plants 12 inches apart in the row. Plant at least three or four rows of the same variety in a block for good pollination and ear fill.

Harvesting and Handling—The harvest season for sweet corn is brief because of texture changes and enzymatic conversion of starch to sugar. Harvesting should be done in early morning while air temperature is still cool. If temperature is high when corn is harvested, the field heat should be removed from corn by either plunging ears in cold water or placing them in the refrigerator. This will help maintain fresh-from-the-garden quality of corn. Normally, sweet corn is ready for harvest about 20 days after the first silk appears on the ear.

Insect Treatments: **1.** Malathion 50% EC, **2.** Carbaryl 50% WP, (Sevin), **3.** Pyrethrins, **4.** Imidacloprid (Bayer FCVIC), **5.** Cyfluthrin (Multi-Insect Killer), **6.** Bifenthrin 0.3% + zeta-cypermethrin 0.075% EC (Ortho Bug-B-Gon Insect Killer for Lawns and Garden), **7.** Bacillus thuringiensis var kurstaki, **8.** Bacillus thuringiensis var san diego, **9.** Carbaryl 5% B (Sevin), **10.** Insecticidal soap, **11.** Neem, **12.** Horticultural Oil, **13.** Bonide Eight Flower and Vegetable 0.115% granules, **14.** Permethrin (Bonide Eight Insect Control Vegetable Fruit and Flower Concentrate), **15.** Spinosad (Captan Jacks Dead Bug Brew), **16.** Acetamiprid (Ortho Bug-B-Gone Systemic Insect Killer) 0.5%

Diseases

Bacterial Wilt (bacterium)—Leaves show long, pale green or tan dead streaks; symptoms can be confused with other leaf blight diseases; early infection may result in stunting, wilting and death of plants. Use resistant varieties; use approved insecticides on corn seedlings to control corn flea beetles that carry the disease-causing bacteria.

Smut (fungus)—Swellings or galls on leaves, stems, ears or tassels that are shiny, greenish-white color at first; galls continue to enlarge, turn black and break open, exposing a black, dusty spore mass. Rotate corn in garden; take care to prevent injuries to plants; remove and destroy galls as they occur and before they break open.

Corn Stunting Diseases (viruses)—Yellowing, mosaic on leaves; stunting of plants; often no ears produced; plant may show purple color; disease carried to corn by aphids and leafhoppers from nearby Johnson grass. Destroy Johnson grass; use resistant corn varieties.

Insects

See pages 25-28 for insect descriptions.

| Treatments | (see footnote below) |
|----------------------------|----------------------|
| Aphids | 6, 10, 11, 12 |
| Armyworms..... | 2, 5, 6, 7, 14, 15 |
| Corn Earworms | 2, 5, 6, 7, 14, 15 |
| Cucumber Beetles..... | 2, 5, 6 |
| Cutworms..... | 5, 6, 9 |
| European Corn Borers | 2, 5, 6, 7, 14, 15 |
| Flea Beetles | 2, 6, 5, 11 |
| Grasshoppers..... | 2, 5, 6, 9 |
| Japanese Beetles | 2, 6 |
| Leafhoppers..... | 2, 6, 11, 12 |
| Sowbugs..... | 9 |
| Stink bugs | 5, 6 |

Sweet Potatoes

Sweet potatoes need a long growing time and medium to light sandy soils which are well-drained and relatively low in nitrogen. Excess nitrogen and heavy applications of fresh animal manures cause long, spindly roots of low quality. Heavy, tight soils cause misshaped roots.

There are two types of sweet potatoes—moist- and dry-flesh types. Moist-flesh or “yam” type is most popular. Root skin color varies from yellow to white for dry- or firm-flesh varieties, to bronze, red, pink and orange for moist types.

Plant Source—Most home gardeners buy transplants or “slips” from a local plant

grower. If you are producing transplants, the potatoes should be bedded in a greenhouse or hotbed (75° to 80°F preferred) about five to six weeks before field setting date. Use only disease-free potatoes.

Ordinarily, ½ bushel will cover 8 to 10 square feet of bed surface and produce about 1000 transplants. The roots should be covered with 3 to 4 inches of sand and then watered down.

Planting—Shape rows into ridges about 10 inches high before planting. Space rows about 3 feet apart, and place plants in the row every 12 inches. Soil pH should be 5.2 to 6.7. Temperatures below 55°F can be detrimental.

A starter solution is recommended after plants are set. Add ¼ pound of 20% nitrogen fertilizer to 5 gallons of water and use about 1 cup of this solution per plant.

Harvesting—Sweet potatoes can be harvested any time they reach a usable size. Sweet potatoes continue to grow until vines are killed by frost. You should harvest the crop when the greatest number of 6- to 8-ounce potatoes are found in the hill. Sample digging will provide this information. A good practice is to clip vines before frost occurs. The crop can then be harvested easily with less damage to potatoes. Plow or spade one row at a time and pick up potatoes. To reduce rotting in storage, be sure potatoes are clean, dry and free of injury.

Curing/Storage—Stack crates or baskets in storage space. Place them 6 to 8 inches off the floor and 12 to 15 inches from the walls to allow for adequate ventilation. Curing requires 7 to 10 days if temperature can be maintained at 80° to 85°F with 70% to 90% relative humidity. Extend the curing period to two or three weeks if the temperature is under 75°F. After curing is complete, keep potatoes in a place as near 55°F as possible with relative humidity of 85%.

Diseases

Scurf (fungus)—Irregular purple-brown discolored areas on roots; color only skin deep but affects keeping quality of stored roots. Use only disease-free potato roots for bedding; cut plants above soil line and reroor plant cuttings into new soil. Dip transplants in a dilute bleach (1:5) solution before planting.

Insects

See pages 25-28 for insect descriptions.

| Treatments | (see footnote below) |
|--------------------|----------------------|
| Flea Beetles | 3, 10, 11 |

Swiss Chard

Swiss chard can be grown either for greens or its large, fleshy leaf stalks. A hardy plant, Swiss chard will withstand hot weather from spring to late fall better than most greens.

Planting and Care—Plants may be started in the greenhouse or hotbed and transplanted in the open after danger of hard frost is past, or seed may be sown in the garden where plants are to grow.

Space rows about 18 inches apart for hand cultivation and 30 to 36 inches apart for mechanical cultivators. Sow seeds ¾ inch deep and thin plants eventually to 10 to 12 inches apart in the row.

Harvesting—Several harvests can be made from the same plants through the growing season. Outer leaves should be removed near ground level with a sharp knife, leaving smaller leaves near the center of the plant. It is important not to cut into the growing point or bud in the center of the plant so new leaves can continue to develop.

Insects

See pages 25-28 for insect descriptions.

| Treatments | (see footnote below) |
|------------------------------|----------------------|
| Aphids | 1, 4, 10, 11 |
| Blister Beetles | 3 |
| Colorado Potato Beetles..... | 8, 11 |
| Cutworms..... | 9 |
| Flea Beetles | 2, 11 |

Tomatoes

Tomatoes grow under a wide range of conditions with minimum effort. They require relatively little space for large production. Each tomato plant, if properly cared for, can be expected to yield 10 to 15 pounds of fruit.

The tomato is a warm-season plant and should not be set outside until danger of frost is past. This date varies from April 20 in western Kentucky to May 15 in northern Kentucky.

Insect Treatments: 1. Malathion 50% EC, 2. Carbaryl 50% WP, (Sevin), 3. Pyrethrins, 4. Imidacloprid (Bayer FCVIC), 5. Cyfluthrin (Multi-Insect Killer), 6. Bifenthrin 0.3% + zeta-cypermethrin 0.075% EC (Ortho Bug-B-Gon Insect Killer for Lawns and Garden), 7. Bacillus thuringiensis var kurstaki, 8. Bacillus thuringiensis var san diego, 9. Carbaryl 5% B (Sevin), 10. Insecticidal soap, 11. Neem, 12. Horticultural Oil, 13. Bonide Eight Flower and Vegetable 0.115% granules, 14. Permethrin (Bonide Eight Insect Control Vegetable Fruit and Flower Concentrate), 15. Spinosad (Captan Jacks Dead Bug Brew), 16. Acetamiprid (Ortho Bug-B-Gone Systemic Insect Killer) 0.5%

Fruits vary from small cherry sizes to large baseball sizes. Shapes range from plum to round to pear, and colors vary from greenish white through yellow, orange, pink and red. Growth habits also vary, but those which have indeterminate growth habit and produce fruit over a long period of time are most desirable for the home garden. Select a variety with resistance to plant diseases, especially to fusarium wilt.

Planting—Select stocky transplants about 6 to 10 inches tall. Set tomato transplants in the garden a little deeper than the pot in which they were grown. Starter fertilizer should be used around transplants.

Since plants should be pruned and staked, space them 24 inches apart in rows 3 feet apart.

Fertilization—Tomato plants benefit from additional fertilizer after fruit has set. When first fruits reach golf ball size, scatter 1 Tbs ammonium nitrate in a 6- to 10-inch circle around each plant. Water thoroughly and repeat about every two weeks.

Staking—Staking makes the job of caring for tomatoes easier and aids in reducing fruit rots. Drive stakes in soil about 4 to 6 inches from plant, 1 foot deep, soon after transplants are set in the garden. Use wooden stakes 6 feet long and 1 ½ to 2 inches wide. Attach heavy twine at 10-inch intervals to stakes. As tomatoes grow, pull them up alongside stakes and tie loosely. Tomatoes may also be set along a fence or trellis and tied there.

Pruning—If tomatoes are staked, they need to be pruned to either one or two main stems. At the junction of each leaf and first main stem, a new shoot will develop. If plants are trained to two stems, choose one of these shoots, normally at the first or second leaf stem junction, for your second main stem. Once each week, remove all other shoots to hold the plant to these two stems. Remove shoots by pinching them off with your fingers.

Caging—Large-vined tomatoes benefit from being grown in wire cages, show fewer cracks and sunburn, ripen more uniformly, show fewer green shoulders and produce fewer cull fruits than tomatoes which are pruned and tied to stakes or allowed to sprawl on the ground.

Erect cages soon after plants have been set out. Otherwise, breakage often occurs when you try to train stems which have grown too long.

One material suggested for cage use is concrete reinforcing wire (6-inch mesh) which gives good support and allows you to reach through to pick tomatoes. However, this wire will rust, so after making cages, it's a good idea to paint them with rust-resistant paint.

Galvanized fence wire lasts many seasons without painting. Be sure to get 4- to 6-inch mesh so your hand will fit through for harvesting. Galvanized fence wire comes either welded or woven. Since welded joints occasionally break, woven is the best type to use.

Long-term Storage—Mature green or slightly pink tomatoes can be stored for one to two months. Spread them on a rack covered with newspaper and sort them according to ripeness. Then store them in the dark, covered with paper to retain moisture. Tomatoes put in sunlight become bitter. Check them every week and remove ripe or damaged ones.

Matured green tomatoes will be ripe enough to eat in about two weeks if kept at 65° to 70°F. The ripening period can be slowed to three or four weeks if the temperature is 55°F. (Don't let it get below 50°F.) The immature ones will take longer at either temperature.

Another way to ripen tomatoes is to pull the vines just before a freeze and hang them upside down in your garage or basement. The fruits will ripen gradually and may be picked as needed. See "Storing Vegetables" on page 29.

Diseases

Early Blight (fungus)—Leaves have dark brown spots with concentric rings or target board pattern in the spots; disease begins on lower foliage and works up with severely affected leaves shriveling and dying; similar spots can occur on stems and fruits; can be confused with other leaf spots, but this is most common. Maintain proper fertility. Spray foliage with fungicide at first sign of disease and as needed (weekly during hot, humid weather) thereafter; use chlorothalonil, mancozeb or fixed copper.

(Good coverage is needed.) Make second planting in midsummer for fall crop. A few early blight tolerant varieties are now available.

Fusarium and Verticillium Wilt (fungi)—Leaves wilt, turn yellow and fall, often on one side of plant before the other; plants may be stunted or killed; inner "bark" or vascular tissue may be yellow, brown or have dark discoloration that can be seen when lower stem is cut open; Verticillium more likely under cool growing conditions, Fusarium when soils are warm. Use resistant tomato varieties; varieties labeled "V," "F" or "N" are resistant to Verticillium, Fusarium or root knot nematodes; "VFN" varieties are resistant to all three; use recommended varieties; rotate with other garden crops.

Late Blight (fungus)—See "Potato" for description of foliar symptoms; fruits may develop dark brown or greenish blemishes, usually on stem and during cool, moist weather. See "Tomato Early Blight" for fungicides. Use disease-free transplants and control late blight in potatoes.

Septoria Leaf Spot (fungus)—Small, brown, circular spots on leaves. Similar to early blight, but often develops earlier in the season. See "Early Blight."

Southern Stem Blight—See "Symptoms of Some General Diseases and Their Management" on page 23.

Virus Diseases—See "Symptoms of Some General Diseases and Their Management" on page 23.

Other Problems

Blossom End Rot (environmental)—Black or brown leathery decay on blossom end of fruit; dark area often sunken and fruits practically worthless. Irrigate to maintain uniform soil moisture levels; mulch plants to conserve moisture; avoid deep cultivation and root pruning; lime soil as needed according to soil test results.

Walnut Wilt (environmental)—Grown plants which set fruit suddenly wilt and die; internal vascular browning in lower stem; strictly associated with plants growing near walnut trees or in soil with decaying walnut roots. Do not plant tomatoes, eggplant or peppers near walnut (*Juglans* spp.) trees.

Insect Treatments: **1.** Malathion 50% EC, **2.** Carbaryl 50% WP, (Sevin), **3.** Pyrethrins, **4.** Imidacloprid (Bayer FCVIC), **5.** Cyfluthrin (Multi-Insect Killer), **6.** Bifenthrin 0.3% + zeta-cypermethrin 0.075% EC (Ortho Bug-B-Gon Insect Killer for Lawns and Garden), **7.** *Bacillus thuringiensis* var *kurstaki*, **8.** *Bacillus thuringiensis* var *san diego*, **9.** Carbaryl 5% B (Sevin), **10.** Insecticidal soap, **11.** Neem, **12.** Horticultural Oil, **13.** Bonide Eight Flower and Vegetable 0.115% granules, **14.** Permethrin (Bonide Eight Insect Control Vegetable Fruit and Flower Concentrate), **15.** Spinosad (Captan Jacks Dead Bug Brew), **16.** Acetamiprid (Ortho Bug-B-Gone Systemic Insect Killer) 0.5%

Insects

See pages 25-28 for insect descriptions.

Treatments

(see footnote below)

| | |
|--|----------------------------|
| Aphids | 1, 4, 6, 10, 11, 12, 16 |
| Blister Beetles | 2, 16 |
| Cabbage Loopers..... | 5, 6, 7, 14, 15, 16 |
| Colorado Potato Beetles... | 4, 5, 6, 8, 11, 14, 15, 16 |
| Corn Earworms (tomato fruitworms) | 2, 5, 6, 7, 14, 16 |
| Cutworms..... | 2, 5, 6, 9, 13 |
| Flea Beetles | 2, 4, 5, 6, 11, 15 |
| Hornworms..... | 2, 5, 6, 7, 14, 15, 16 |
| Mites | 1, 10 |
| Sowbugs..... | 9, 13 |
| Stink bugs | 5, 6, 16 |
| Whiteflies | 1, 4, 6, 10, 12, 16 |

Turnips

Turnips are a rapidly maturing, cool-season crop which can be planted for late spring or late fall harvest in Kentucky. Some cultivars are grown only for their leaves or “greens,” while others are grown for their fleshy roots. Turnip greens are rich in calcium, iron and vitamin A. The white-fleshed group of turnips is recommended for roots.

Planting—For spring turnips, seed should be planted around March 15 or as soon as ground can be worked in spring. For a late fall turnip crop, seed should be sown the latter part of July or first of August.

It is a common practice to broadcast turnip seed. However, drilling seed ½ inch deep in rows 12 to 15 inches apart results in more uniform growth.

When plants have become established, thin them to 3 to 4 inches apart in the row.

Harvesting and Storage—Harvest turnips when they reach 2 to 3 inches in diameter. Large turnips tend to become woody. After growth stops in the fall, turnips can be left in the garden, if protected from freezing. They may also be kept in the refrigerator for several months.

Insects

See pages 25-28 for insect descriptions.

Treatments

(see footnote below)

| | |
|----------------------------------|----------|
| Aphids | 1, 4, 11 |
| Cabbage Loopers..... | 7 |
| Cutworms..... | 9 |
| Flea Beetles | 2, 4, 11 |
| Garden Webworms | 1 |
| Root Maggots & Seed Maggots..... | 1 |
| Sowbugs..... | 9 |

Watermelons

Watermelons are a warm-season, frost-sensitive vine crop and require a lot of garden area for growing because of large vines. Therefore, they are generally not grown in small gardens. Types range from large, 30-pound fruits to small, round, “icebox types” weighing between 5 and 10 pounds. There are also yellow-fleshed types, but red-fleshed types are most popular.

Seedless watermelons are a triploid type. They require a diploid (regular seeded) watermelon for pollination.

Planting or Transplanting—For early harvest, grow seed in peat pots or similar containers in a greenhouse or hotbed three to four weeks before the last frost, then transplant to the garden. Watermelons grow well on black plastic mulch.

Watermelons may also be direct-seeded. Plant two to three seeds per hill about 1 inch deep after danger of frost is past. Space hills 6 to 8 feet apart in the row with rows 6 feet apart. If spaced too closely, bees cannot get into plants to pollinate them properly and weed control is nearly impossible.

Pollination—Since male and female flowers are separate on the same plant, bees must carry pollen from flower to flower to ensure good fruit set and development. Apply insecticides late in the day to avoid killing bees.

Harvesting—Watermelons should be harvested when fully ripe. This stage is difficult to determine. “Thumping” the fruit is not a reliable indicator of fruit maturity. The presence of a dead tendril at the point where the fruit is attached to the vine helps in determining when to harvest. Also, checking for a change in color on the belly or ground spot of the watermelon is a good way to check for maturity. At maturity, the spot will appear creamy white to yellow.

Diseases: see “Cucumber”

Insects

See pages 25-28 for insect descriptions.

Treatments

(see footnote below)

| | |
|-----------------------|------------------|
| Aphids | 4, 6, 11, 16 |
| Cabbage Looper..... | 7, 6, 14, 16 |
| Cucumber Beetles..... | 4, 6, 14, 16 |
| Cutworms..... | 6, 13 |
| Leafhoppers..... | 4, 6, 11, 14, 16 |
| Mites | 10 |

Insect Treatments: **1.** Malathion 50% EC, **2.** Carbaryl 50% WP, (Sevin), **3.** Pyrethrins, **4.** Imidacloprid (Bayer FCVIC), **5.** Cyfluthrin (Multi-Insect Killer), **6.** Bifenthrin 0.3% + zeta-cypermethrin 0.075% EC (Ortho Bug-B-Gon Insect Killer for Lawns and Garden), **7.** Bacillus thuringiensis var kurstaki, **8.** Bacillus thuringiensis var san diego, **9.** Carbaryl 5% B (Sevin), **10.** Insecticidal soap, **11.** Neem, **12.** Horticultural Oil, **13.** Bonide Eight Flower and Vegetable 0.115% granules, **14.** Permethrin (Bonide Eight Insect Control Vegetable Fruit and Flower Concentrate), **15.** Spinosad (Captan Jacks Dead Bug Brew), **16.** Acetamiprid (Ortho Bug-B-Gone Systemic Insect Killer) 0.5%

